

Product Directory



Table of Contents

Ankle and Foot

Introduction	6
Features / Benefits	6
Indications / Contraindications	7
Product Selection Guide	8-9
NaviGAIT	10
ToeUP	11
Ypsilon Flow ½	12
ToeOFF 2.0	13
ToeOFF 2½	14
ToeOFF Flow 2½	15
ToeOFF Short	16
BlueROCKER 2.0	17
BlueROCKER 2½	18
BlueROCKER Short	19
Carbon Footplate	20
CoverKIT	20
KiddieFLOW	21
KiddieGAIT	22
KiddieROCKER	23
Paediatric SoftSHELL	24
Surestep SMO	25
Trial Braces	26-28
Accessories	29-31

Hip

SWASH Introduction	34
SWASH Steady & Go	36-37
SWASH Replacement Components	38

Contracture Management

MultiMotion	40-45
MultiStatic	46

Dynamic Textile Orthosis

Elements Body	48-49
Elements Body Trial Lumbar Wrap	50
Elements Body Trial Sleeve	51
HyMo	52-53

Wrist and Thumb

S.O.T Thumb	54
S.O.T Resting Splint	55
Selection Childrens Thumb and Wrist	56
Selection Wrist and Thumb	57-61
Selection FingerLoop	62

Knee

COMBO	64-65
CROSS Hyperextension Knee	66
Selection Knee	67-68
Elements Stretch Up	68
CHECK Knee	69
OActive 2	72
Trulign OA	73
Catalyst Propel OA	73

Boston Brace

Introduction	76-77
The Original Boston Scoliosis Brace	78
Boston Night Brace	79
Boston Overlap Brace	80
Boston Soft Body Jacket	80
Boston Lite	81
Boston Body Jacket	82
Boston Soft AFO	84
Boston Hip Abduction Brace	85
Universal Spinal Measurement Form	86
Night Brace Measurement Form	87
Stock Size Chart	88
Boston Brace Vest	89
Accessories	90-91
Colour Options	92-93

General Terms & Conditions of Sale

Allard AFO Warranty



Foot & Ankle Orthoses

The quantum leap in AFO technology

Introduced in 1997, ToeOFF®, the first Allard AFO, is now recognized as a quantum leap in AFO technology. Today hundreds of thousands of individuals with gait impairment now enjoy a higher quality of life, thanks to the stability and dynamic response provided when wearing one of our many carbon composite orthoses. More experience than any company in the industry and our commitment to providing only the highest quality product and customer service continue to position us as the world leader in carbon composite AFO technology. In pursuit of our drive to expand our "Support for Better Life", our product development team aggressively researches new materials, technology, and product designs that will extend the opportunity for improved gait and walking capacity to more and more individuals with lower extremity deficiencies.



Anterior Design

Allard AFOs extend up from the footplate onto the anterior surface of the leg to avoid pressure on the calf muscles and Achilles tendon. This allows for a dynamic floor reaction response to assist with propulsion and knee extension

Lateral Strut

The strut is placed on the lateral side of the footplate to create stability and function. It also allows for more functional use by bilateral users.

Light Weight

The composition of Carbon fiber, Fiberglass and Kevlar produces an extremely lightweight yet structurally superior design, which increases user compliance.

Open Heel

The open heel design allows the calcaneus to invert and evert to activate the natural biomechanical chain reaction to occur to achieve a closer to normal gait and eliminates uncomfortable pressure on the back of the leg or heel.

Comfortable

As the shin plate comes on the anterior surface of the leg, it provides a more comfortable design for the user.

Thin

The extreme thinness of the product makes it light and almost invisible under trousers.

Dynamic Footplate

The unique layup and the shape of the footplate contributes to a more dynamic, functional, and fluid gait pattern.

Fits in Shoe

The thinness of the footplate often avoids the need to increase the shoe size.

Graded Stability

To be able to accommodate different users' needs, the sizes and products are graded in both stability and dynamic response.

Indications & Contraindications

Indications

The Allard AFO for adults is designed to manage drop foot in conditions such as Stroke, Multiple Sclerosis, Post-Polio Syndrome, Muscular Dystrophy, Spinal Cord Injuries, Traumatic Brain Injuries, Guillian-Barre Syndrome, Charcot-Marie-Tooth, Myelomeningocele, Neuropathy or Cerebral Palsy. They can also support gait in conditions such as Posterior Tibialis Tendon Dysfunction (PTTD) and toe amputations. The BlueROCKER® range can be used for partial foot amputations, most proximal level is Chopart.

The paediatric AFOs are designed to support foot drop, gait deviations secondary to proprioceptive deficit (either unstable or low-tone gait), toe-walking with no midfoot collapse, low tone crouch gait in conditions such as Spina Bifida, Cerebral Palsy, Muscular Dystrophy and Myelomeningocele.

Contraindications

Allard Adult AFO should not be used when patients present with:

- Foot and /or leg ulcers
- Moderate to severe edema
- Moderate to severe foot deformities
- Severe spasticity
- Severe proximal deficits (e.g. Quadriceps spasticity,
- Genu Valgum or Varum, Genu Recurvatum)

Allard paediatric AFO should not be used when patients present with:

- Lacking ROM towards dorsiflexion (needs at least 5° dorsiflexion past neutral)
- Very rigid foot structure
- Quadriceps spasticity
- Fixed postural Pes Valgus or Pes Varus
- Excessive postural Genu Valgum, Genu Varum or Genu Recurvatum

Limitations

When Genu-recurvatum cannot be orthotically managed (such as with insoles or wedges), COMBO™ (a knee orthosis attachment for ToeOFF® and BlueROCKER®) or knee orthosis CROSS™ may be suitable solutions. Further information on COMBO™ is available in this catalogue and on our website.

Note

Professionals selecting, fitting and customizing these orthoses should exercise due professional judgment throughout and provide appropriate education to the patient or caregiver, to minimize the potential associated risk. These risks may include the contraindications identified above as well as risks associated with the unique attributes of the patient or the caregiver circumstances.

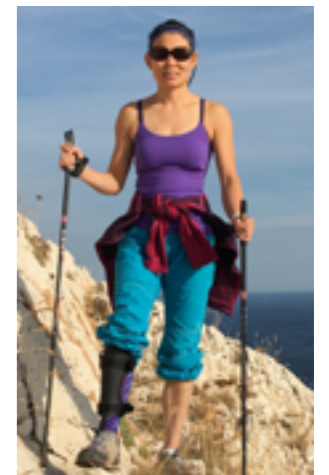
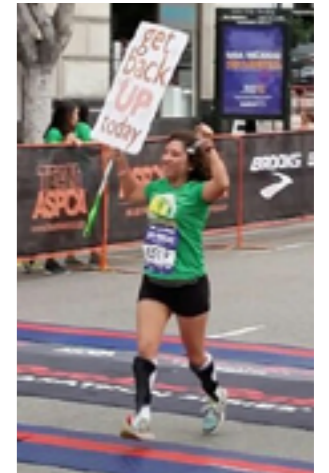

Product Selection Guide

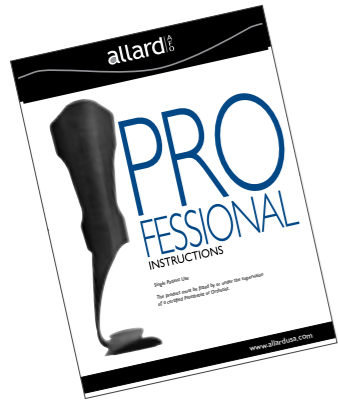

Further information about intended use, indications and contraindications, and suggested modifications to assure optimum alignment and patient comfort can be found in the Professional Instructions packed together with each Allard AFO or can be downloaded from allardint.com. You can also view our 8-step videos on our website.

The scales on this page and chart on following page are provided as general guidelines only. Each individual, based on their unique deficits, gait patterns, proprioceptive response, and lifestyle needs, will respond differently to any orthotic device. This will influence the function and compliance results.

Allard AFO Product Rigidity Scale

Each Allard AFO offers different rigidity to provide the amount of support needed without over-bracing. The chart below shows the variance in the amount of support each AFO offers. For example, Ypsilon® Flow 1/2 would be considered for patients requiring minimum support while BlueROCKER® for those that require most support.

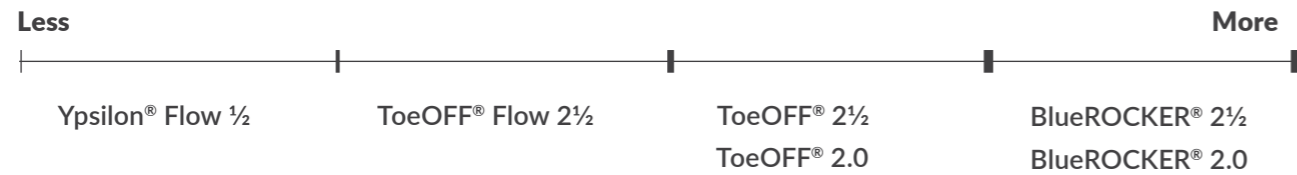

Allard AFO function scale

As an example, Ypsilon® FLOW 1/2 allows for the most ROM while BlueROCKER® offers the least. On the other hand, if you look at stability, BlueROCKER® offers the most whereas Ypsilon® FLOW 1/2 will provide the least stability.

	Ypsilon® Flow 1/2	ToeOFF® Flow 2 1/2	ToeOFF® 2 1/2 ToeOFF® 2.0	BlueROCKER® 2 1/2 BlueROCKER® 2.0
Allows Range Of Motion	●●●●○	●●●○	●●○○	●○○○
M-L Stability	●●●○○	●●●○	●●●●	●●●●●
A-P Stability	●●●○○	●●●○	●●●●	●●●●●
Dorsiflexion Assist	●●●○○	●●●○	●●●●	●●●●●
Spasticity Control	●●●○○	●●●○	●●●●	●●●●●
Proximal Control	●●●○○	●●●○	●●●●	●●●●●

Allard Muscle Weakness Guide

These charts are based on R&D studies, practitioner, and patient feedback. When patient's anatomical or function needs fall out of the parameters of the Product Rigidity or Function Scale, Allard also offers to fabricate Custom Carbon Composite AFOs. Ask Customer Service for ordering information.

Muscle function None or limited function ● Moderate function ● Full function ●

LIMITED Proximal weakness



MORE Proximal weakness





NAVIGAIT™

Navigait is an alternative for users with a mild foot drop. The amount of dorsiflexion is easily adjusted with an elastic coil to accommodate the user's specific needs.

Indications: Intended to support a foot when the ability to actively dorsiflex is reduced due to conditions such as Stroke, Multiple Sclerosis, Post Polio Syndrome.

Contraindications: Navigait should not be used by patients who present with spasticity or severe oedema.

Item No.	Description	Size	Anterior section height
284100010	NAVIGAIT	XSmall	23 cm
28410 0011	NAVIGAIT	Small/Medium	26,5 cm
28410 0013	NAVIGAIT	Large/XLarge	30 cm
28412 0011	Extra strap w/coil	Small/Medium	
28412 0013	Extra strap w/coil	Large/XLarge	
28413 0010	Extra Strong/Shorter Strap w/coil	XSmall	
28413 0011	Extra Strong/Shorter Strap w/coil	Small/Medium	
28413 0013	Extra Strong/shorter Strap w/coil	Large/XLarge	
28414 0010	Replacement Strap	XSmall	
28414 0011	Replacement Strap	Small/Medium	
28414 0013	Replacement Strap	Large/XLarge	
			Circumference
28415 0011	NAVIGAIT 4-Foot	Small	21-23 cm
28415 0012	NAVIGAIT 4-Foot	Medium	23-26 cm
28415 0013	NAVIGAIT 4-Foot	Large	26-29 cm

ToeUP™ Textile ankle foot orthosis

ToeUP is a textile ankle foot orthosis designed for individuals with a mild form of foot drop. This orthosis features a low-profile textile ankle section that fastens above the malleoli (the bony prominence of the ankle). The ankle section is connected using an elastic cord with hooks, which are secured beneath the lacing or within the lacing holes on the shoe. This mechanism provides elevation for the forefoot during ambulation. You can adjust the level of elevation by altering the placement of the hooks or the strap on the ankle section. Additionally, there is a supplementary D-ring to fasten the straps together. ToeUP also offers an optional foot part component for indoor use. It is important to use ToeUP in conjunction with a sock.



Indications:

For patients experiencing mild symptoms of foot drop due to neuro- and/or muscular weakness in dorsiflexion.

Item No.	Model	Size	L/R
285000010	ToeUP - package incl. 28502-28506	XS	Bilateral
285000011	ToeUP - package incl. 28502-28506	S	Bilateral
285000012	ToeUP - package incl. 28502-28506	M	Bilateral
285000013	ToeUP - package incl. 28502-28506	L	Bilateral
285000014	ToeUP - package incl. 28502-28506	XL	Bilateral
285010011	Foot part for indoor use	S	Left
285010012	Foot part for indoor use	M	Left
285010013	Foot part for indoor use	L	Left
285010021	Foot part for indoor use	S	Right
285010022	Foot part for indoor use	M	Right
285010023	Foot part for indoor use	L	Right
285020011	Extra Elastic Cord	XS-S	-
285020013	Extra Elastic Cord	M-L	-
285030000	Extra Hooks	One size, pair	-
285040000	Extra D-Ring	One size	-
285050000	Extra Under Lace Hook	One size	-
285060010	Extra Ankle Section	XS	Bilateral
285060011	Extra Ankle Section	S	Bilateral
285060012	Extra Ankle Section	M	Bilateral
285060013	Extra Ankle Section	L	Bilateral



Ypsilon®Flow ½

Ypsilon®Flow ½ was designed for your active patients or others who require less resistance or more flexibility. The footplate is engineered to allow the orthosis to adapt to and move with the lower leg with less resistance to ground reaction forces while the proximal ends of the “Y” provide fixation points, eliminating pressure on the tibia crest. Ypsilon®Flow 2½ has a heel height of only 7 mm. Ypsilon Flow ½ is supplied complete with tibial pad and strap.

For information on Indications and Contraindications please refer to page 7. More about fitting and product selection can be found in the Allard AFO Professional Instruction.

Item No. Left	Item No. Right	Size	Footplate length	Height	Heel Height
28880 1011	28880 2011	Small	230 mm	355 mm	7 mm
28880 1012	28880 2012	Medium	245 mm	365 mm	7 mm
28880 1013	28880 2013	Large	270 mm	375 mm	7 mm
28880 1014	28880 2014	X-Large	285 mm	385 mm	7 mm

Accessories for Ypsilon Flow ½

Item No.	Description	Size
28884 0012	Tibia pad, bilateral fits 3 sizes	Small/medium/large
28884 0014	Tibia pad, bilateral	X-Large
28885 0000	Strap, bilateral fits all sizes	One Size
28886 0000	ComfortPad	One Size



ToeOFF® 2.0

ToeOFF® 2.0 is the updated version of the Original ToeOFF.® The 2.0 version has shorter wings, alligator style strapping and the MicroFIX is pre-applied on the inside of the tibia plate for faster fitting. The height of size X-Large is 2cm longer than the Original ToeOFF®.

For information on Indications and Contraindications please refer to page 7. More about fitting and product selection can be found in the Allard AFO Professional Instruction.

Item No. Left	Item No. Right	Size	Footplate length	Height
28920 1010	28920 2010	XSmall	21 cm	36 cm
28920 1011	28920 2011	Small	23 cm	38 cm
28920 1012	28920 2012	Medium	24,5 cm	40,5 cm
28920 1013	28920 2013	Large	27 cm	43 cm
28920 1014	28920 2014	XLarge	28,5 cm	45 cm

SoftKIT

Item No.	Description	Size
28750 0010	SoftKIT 2.0	XSmall
28750 0011	SoftKIT 2.0	Small
28750 0012	SoftKIT 2.0	Medium
28750 0013	SoftKIT 2.0	Large
28750 0014	SoftKIT 2.0	XLarge

ComfortKIT

Item No.	Description	Size
28751 0010	ComfortKIT 2.0	XSmall
28751 0011	ComfortKIT 2.0	Small
28751 0012	ComfortKIT 2.0	Medium
28751 0013	ComfortKIT 2.0	Large
28751 0014	ComfortKIT 2.0	XLarge

Replacement Straps

Item No.	Description	Size
28760 0010	Strap Set for 2.0	X-Small
28760 0011	Strap Set for 2.0	Small
28760 0012	Strap Set for 2.0	Medium
28760 0013	Strap Set for 2.0	Large
28760 0014	Strap Set for 2.0	X-Large

Allard UK also offers D-Ring Straps, please see page 29 for ordering details.





ToeOFF® 2½

The Foot Drop Orthosis ToeOFF® 2 ½ has the same dynamic functions and stability as ToeOFF® 2.0 with the exception that the 2 ½ has a lower heel height of 7 mm, to adapt to modern shoes. The toe lift is also lower which results in more space in the toe box. ToeOFF® 2 ½ has MikroFIX pre-applied to simplify the fitting process with the padding. The strap solution is the same as on 2.0, made from a durable and strong material. The straps can be applied on the interior or external side of the AFO.

For information on Indications and Contraindications please refer to page 7. More about fitting and product selection can be found in the Allard AFO Professional Instruction.

Item No. Left	Item No. Right	Size	Footplate length	Height
28980 1010	28980 2010	XSmall	21 cm	36 cm
28980 1011	28980 2011	Small	23 cm	38 cm
28980 1012	28980 2012	Medium	24,5 cm	40,5 cm
28980 1013	28980 2013	Large	27 cm	43 cm
28980 1014	28980 2014	XLarge	28,5 cm	43 cm

SoftKIT

Item No.	Description	Size
28750 0010	SoftKIT 2.0	XSmall
28750 0011	SoftKIT 2.0	Small
28750 0012	SoftKIT 2.0	Medium
28750 0013	SoftKIT 2.0	Large
28750 0014	SoftKIT 2.0	XLarge

ComfortKIT

Item No.	Description	Size
28751 0010	ComfortKIT 2.0	XSmall
28751 0011	ComfortKIT 2.0	Small
28751 0012	ComfortKIT 2.0	Medium
28751 0013	ComfortKIT 2.0	Large
28751 0014	ComfortKIT 2.0	XLarge

Replacement Straps

Item No.	Description	Size
28760 0010	Strap Set 2.0	X-Small
28760 0011	Strap Set 2.0	Small
28760 0012	Strap Set 2.0	Medium
28760 0013	Strap Set 2.0	Large
28760 0014	Strap Set 2.0	X-Large

Allard UK also offers D-Ring Straps, please see page 29 for ordering details.

ToeOFF® Flow 2½

ToeOFF® Flow 2½ is the combination of our extensive experience and development in Carbon Composite AFO manufacturing, together with our Customers' request. ToeOFF® Flow 2½ has a new formula and other benefits:

- Lower heel height ~7 mm, easier to adapt to modern shoes.
- Lower toe lift
- More dynamic and ROM in A-P plane
- Lower, smoother profile of the footplate
- Patent Pending

ToeOFF® Flow 2½ has Mikrofix pre-applied which makes it faster to assemble your choice of SoftKIT™ 2.0, ComfortKIT™ 2.0 or CoverKIT™ 2.0. The closure straps are the same as ToeOFF® 2.0.

For information on Indications and Contraindications please refer to page 7. More about fitting and product selection can be found in the Allard AFO Professional Instruction.

Item No. Left	Item No. Right	Size	Footplate length	Height
28960 1010	28960 2010	XSmall	21 cm	36 cm
28960 1011	28960 2011	Small	23 cm	38 cm
28960 1012	28960 2012	Medium	24,5 cm	40,5 cm
28960 1013	28960 2013	Large	27 cm	43 cm
28960 1014	28960 2014	XLarge	28,5 cm	43 cm

SoftKIT

Item No.	Description	Size
28750 0010	SoftKIT 2.0	XSmall
28750 0011	SoftKIT 2.0	Small
28750 0012	SoftKIT 2.0	Medium
28750 0013	SoftKIT 2.0	Large
28750 0014	SoftKIT 2.0	XLarge

ComfortKIT

Item No.	Description	Size
28751 0010	ComfortKIT 2.0	XSmall
28751 0011	ComfortKIT 2.0	Small
28751 0012	ComfortKIT 2.0	Medium
28751 0013	ComfortKIT 2.0	Large
28751 0014	ComfortKIT 2.0	XLarge

Replacement Straps

Item No.	Description	Size
28760 0010	Strap Set 2.0	X-Small
28760 0011	Strap Set 2.0	Small
28760 0012	Strap Set 2.0	Medium
28760 0013	Strap Set 2.0	Large
28760 0014	Strap Set 2.0	X-Large

Allard UK also offers D-Ring Straps, please see page 29 for ordering details.





ToeOFF® SHORT

ToeOFF® SHORT is specifically developed to accommodate individuals with shorter stature, slightly broader-shaped tibia, and wider foot at the metatarsal area. The SHORT models have a heel height of 7 mm in all sizes.

For information on Indications and Contraindications please refer to page 7. More about fitting and product selection can be found in the Allard AFO Professional Instruction.

Item No. Left	Item No. Right	Description	Size	Footplate length	Height
28990 1011	28990 2011	ToeOFF SHORT	Small	21,5 cm	29,5 cm
28990 1012	28990 2012	ToeOFF SHORT	Medium	23,5 cm	32 cm
28990 1013	28990 2013	ToeOFF SHORT	Large	25,5 cm	34 cm

SoftKIT

Item No.	Description	Size
28391 0011	SoftKIT SHORT	Small
28391 0012	SoftKIT SHORT	Medium
28391 0013	SoftKIT SHORT	Large

Replacement Straps

Item No.	Description	Size
28768 0011	Strap Set	Small
28768 0012	Strap Set	Medium
28768 0013	Strap Set	Large

BlueROCKER® 2.0

BlueROCKER® 2.0 is the updated version of the Original BlueROCKER®. The 2.0 version has shorter wings, alligator style strapping and the MicroFIX is pre-applied on the inside of the tibia plate for faster fitting.

Another feature is the increased height on size X-Large with 2 cm more compared to the Original BlueROCKER®.

For information on Indications and Contraindications please refer to page 7. More about fitting and product selection can be found in the Allard AFO Professional Instruction.

Item No. Left	Item No. Right	Size	Footplate length	Height
28940 1010	28940 2010	XSmall	21 cm	36 cm
28940 1011	28940 2011	Small	23 cm	38 cm
28940 1012	28940 2012	Medium	24,5 cm	40,5 cm
28940 1013	28940 2013	Large	27 cm	43 cm
28940 1014	28940 2014	XLarge	28,5 cm	45 cm

SoftKIT

Item No.	Description	Size
28750 0010	SoftKIT 2.0	XSmall
28750 0011	SoftKIT 2.0	Small
28750 0012	SoftKIT 2.0	Medium
28750 0013	SoftKIT 2.0	Large
28750 0014	SoftKIT 2.0	XLarge

ComfortKIT

Item No.	Description	Size
28751 0010	ComfortKIT 2.0	XSmall
28751 0011	ComfortKIT 2.0	Small
28751 0012	ComfortKIT 2.0	Medium
28751 0013	ComfortKIT 2.0	Large
28751 0014	ComfortKIT 2.0	XLarge

Replacement Straps

Item No.	Description	Size
28760 0010	Strap set 2.0	XSmall
28760 0011	Strap set 2.0	Small
28760 0012	Strap set 2.0	Medium
28760 0013	Strap set 2.0	Large
28760 0014	Strap set 2.0	XLarge

Allard UK also offers D-Ring Straps, please see page 29 for ordering details.





BlueROCKER® 2 ½

The Foot Drop Orthosis BlueROCKER® 2 ½ has the same dynamic functions and stability as a BlueROCKER® 2.0 with exception that the 2 ½ has a lower heel height, 7 mm, to adapt to modern shoes. The toe lift is also slightly lower which results in more space in the toe box. BlueROCKER® 2 ½ has all MikroFIX pre-applied to simplify fitment of the padding. The strap solution is the same as on 2.0, made from a durable and strong material. The straps can be applied for either inside or outside closure on the orthosis.

For information on Indications and Contraindications please refer to page 7. More about fitting and product selection can be found in the Allard AFO Professional Instruction.

Item No. Left	Item No. Right	Size	Footplate length	Height
28970 1010	28970 2010	XSmall	21 cm	36 cm
28970 1011	28970 2011	Small	23 cm	38 cm
28970 1012	28970 2012	Medium	24,5 cm	40,5 cm
28970 1013	28970 2013	Large	27 cm	43 cm
28970 1014	28970 2014	XLarge	28,5 cm	45 cm

SoftKIT

Item No.	Description	Size
28750 0010	SoftKIT 2.0	XSmall
28750 0011	SoftKIT 2.0	Small
28750 0012	SoftKIT 2.0	Medium
28750 0013	SoftKIT 2.0	Large
28750 0014	SoftKIT 2.0	XLarge

ComfortKIT

Item No.	Description	Size
28751 0010	ComfortKIT 2.0	XSmall
28751 0011	ComfortKIT 2.0	Small
28751 0012	ComfortKIT 2.0	Medium
28751 0013	ComfortKIT 2.0	Large
28751 0014	ComfortKIT 2.0	XLarge

Replacement Straps

Item No.	Description	Size
28760 0010	Strap set 2.0	XSmall
28760 0011	Strap set 2.0	Small
28760 0012	Strap set 2.0	Medium
28760 0013	Strap set 2.0	Large
28760 0014	Strap set 2.0	XLarge

Allard UK also offers D-Ring Straps, please see page 29 for ordering details.

BlueROCKER® SHORT

SHORT models are specifically developed to accommodate individuals with a shorter stature, slightly broader-shaped tibia, and wider foot at the metatarsal area. Tibia padding should always be worn for patient comfort. The SHORT models have a heel height of 7 mm in all sizes.

For information on Indications and Contraindications please refer to page 7. More about fitting and product selection can be found in the Allard AFO Professional Instruction.

Item No. Left	Item No. Right	Description	Size	Footplate length	Height
28995 1011	28995 2011	BlueROCKER SHORT	Small	21,5 cm	29,5 cm
28995 1012	28995 2012	BlueROCKER SHORT	Medium	23,5 cm	32 cm
28995 1013	28995 2013	BlueROCKER SHORT	Large	25,5 cm	34 cm

SoftKIT

Item No.	Description	Size
28391 0011	SoftKIT SHORT	Small
28391 0012	SoftKIT SHORT	Medium
28391 0013	SoftKIT SHORT	Large

Replacement Straps

Item No.	Description	Size
28768 0011	Strap Set	Small
28768 0012	Strap Set	Medium
28768 0013	Strap Set	Large

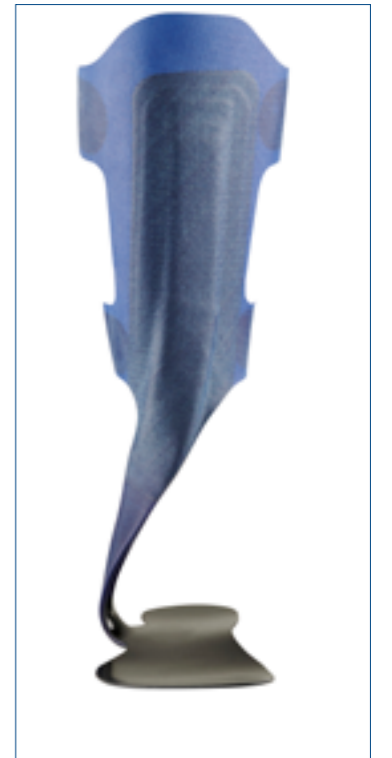



Carbon Footplate

The Carbon Footplate serves the purpose of safeguarding the MTP (metatarsophalangeal) joints and the forefoot. It achieves this by restricting the range of motion, evenly distributing pressure in the forefoot, and aiding in the smooth transition of weight during ambulation. Furthermore, this footplate can be utilized to gradually restore mobility following a period of immobilization, typically in conjunction with a post-operative shoe or walker. It has the potential to enhance balance for individuals who have undergone toe amputation, specifically the fourth (IV) and/or fifth (V) toes. For optimal usage, it is essential to use an insole or custom foot orthotic in conjunction with the footplate.

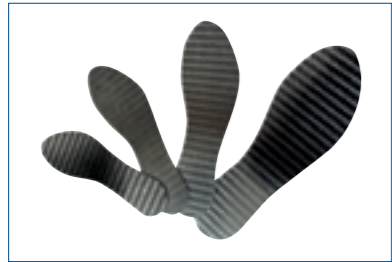

Indications:

Hallux rigidus, Hallux limitus, stress fractures, and various other injuries or arthritic conditions in the forefoot and/or midfoot.

Item No.	Size	L/R	Width	Length
280351011	Small	Left	77mm	235mm
280351012	Medium	Left	80mm	255mm
280351013	Large	Left	90mm	275mm
280351014	X-Large	Left	99mm	305mm
280352011	Small	Right	77mm	235mm
280352012	Medium	Right	80mm	255mm
280352013	Large	Right	90mm	275mm
280352014	X-Large	Right	99mm	305mm



CoverKIT™

CoverKIT™ 2.0 combines our SoftKIT™ interface with a thin textile front to form a sleeve that slides over the anterior shell.

- Compatible with ToeOFF® 2.0, ToeOFF® Flow 2½, ToeOFF® 2½,
- BlueROCKER® 2.0 and BlueROCKER® 2½.
- Smooth, sleek appearance!
- Easy to apply – just pull the CoverKIT™ onto the leg like you would a leg warmer.
- Stretch up the textile front, slide on your compatible AFO and “cover up” the AFO by pulling down the textile front.
- Provides a smooth surface that extends all the way down the strut to the foot plate allowing pant legs to slide easily over the brace.
- If needed, the original straps, supplied with the AFO, can be used together with the CoverKIT™.

Item No.	Size	Calf Circumference
28765 0010	X-Small	31 - 34 cm
28765 0011	Small	34 - 37 cm
28765 0012	Medium	37 - 41 cm
28765 0013	Large	41 - 46 cm
28765 0014	X-Large	46 - 51 cm



KiddieFLOW™

Unlike KiddieGAIT®, KiddieFLOW™ is more flexible in the heel and toe area of the footplate and allows a greater range of motion.

KiddieFLOW™ is based on the same principles as our adult FLOW models and retains the same geometry as KiddieGAIT® and KiddieROCKER®. The orthosis supports the dorsiflexion of the foot in the swing phase, provides better control of foot positioning in the late swing phase, which in turn improves stability in the stance phase.

At the same time, the softer footplate provides easier roll off at the end of the stance phase. For a combination of increased A / P and M / L control, KiddieFLOW™, in addition to our other children's models, can also be combined with individual insoles or SMO.

Item No. Left	Item No. Right	Description	Size	Footplate length	Height
28891 1011	28891 2011	KiddieFLOW	Small	16 cm	22 cm
28891 1012	28891 2012	KiddieFLOW	Medium	18 cm	25,7 cm
28891 1013	28891 2013	KiddieFLOW	Large	20 cm	29,5 cm
28891 1014	28891 2014	KiddieFLOW	XLarge	21 cm	31,5 cm

Allard UK also offers D-Ring Straps, please see page 29 for ordering details.





For information on Indications and Contraindications please refer to page 7. More about fitting and product selection can be found in the Allard AFO Professional Instruction.

KiddieGAIT®

KiddieGAIT® gives toddlers an orthosis that will allow their little feet to move in a more fluid and natural gait pattern. The AFO support the kids step thru Swing Phase and control the foot movement in several planes thru Stance phase. The anterior shell on the frontal side of lower leg also supports in other proximal problems, such as knee hyperextension or "Crouch gait" KiddieGAIT® is supposed to be used in combination with an custom made insole or SMO to control foot position.

Item No. Left	Item No. Right	Description	Size	Footplate length	Height
28372 1008	28372 2008	KiddieGAIT BABY	BabySmall	11 cm	15 cm
28372 1009	28372 2009	KiddieGAIT BABY	BabyMedium	12,5 cm	18 cm
28372 1010	28372 2010	KiddieGAIT BABY	BabyLarge	14 cm	20 cm
28900 1011	28900 2011	KiddieGAIT Youth	Small	16 cm	22 cm
28900 1012	28900 2012	KiddieGAIT Youth	Medium	18 cm	25,7 cm
28900 1013	28900 2013	KiddieGAIT Youth	Large	20 cm	29,5 cm
28900 1014	28900 2014	KiddieGAIT Youth	XLarge	21 cm	31,5 cm

SoftKIT

Item No.	Description	Size
28397 0008	Interface for KiddieGAIT BABY	BabySmall
28397 0009	Interface for KiddieGAIT BABY	BabyMedium
28397 0010	Interface for KiddieGAIT BABY	BabyLarge
28378 0011	Interface for KiddieFLOW/KiddieGAIT/KiddieROCKER	Small
28378 0012	Interface for KiddieFLOW/KiddieGAIT/KiddieROCKER	Medium
28378 0013	Interface for KiddieFLOW/KiddieGAIT/KiddieROCKER	Large
28378 0014	Interface for KiddieFLOW/KiddieGAIT/KiddieROCKER	XLarge

ComfortKIT

Item No.	Description	Size
28418 0011	Interface for KiddieFLOW/KiddieGAIT/KiddieROCKER	Small
28418 0012	Interface for KiddieFLOW/KiddieGAIT/KiddieROCKER	Medium
28418 0013	Interface for KiddieFLOW/KiddieGAIT/KiddieROCKER	Large
28418 0014	Interface for KiddieFLOW/KiddieGAIT/KiddieROCKER	XLarge

Replacement straps

Item No.	Description	Size
28368 0011	Strap Set for KiddieFLOW/KiddieGAIT/KiddieROCKER	Small
28368 0012	Strap Set for KiddieFLOW/KiddieGAIT/KiddieROCKER	Medium
28368 0013	Strap Set for KiddieFLOW/KiddieGAIT/KiddieROCKER	Large/ XLarge

Allard UK also offers D-Ring Straps, please see page 29 for ordering details.

KiddieROCKER®

KiddieROCKER® provides extra rigidity to enhance balance and posture control, especially for children with weak quadriceps muscles. KiddieROCKER® was developed for the children with more involved pathology than only footdrop.

- Carbon composite with anterior shell, lateral strut, and an engineered footplate with an open calcaneal design.
- Designed to allow integration of your custom foot orthotic to help control ground-up forces.
- Anterior shell to assist in management of proximal deficits by helping to manage either knee hyperextension or crouch gait.

Item No. Left	Item No. Right	Description	Size	Footplate length	Height
28902 1011	28902 2011	KiddieROCKER Youth	Small	16 cm	22 cm
28902 1012	28902 2012	KiddieROCKER Youth	Medium	18 cm	25,7 cm
28902 1013	28902 2013	KiddieROCKER Youth	Large	20 cm	29,5 cm
28902 1014	28902 2014	KiddieROCKER Youth	XLarge	21 cm	31,5 cm

SoftKIT

Item No.	Description	Size
28378 0011	Interface for KiddieFLOW/KiddieGAIT/KiddieROCKER	Small
28378 0012	Interface for KiddieFLOW/KiddieGAIT/KiddieROCKER	Medium
28378 0013	Interface for KiddieFLOW/KiddieGAIT/KiddieROCKER	Large
28378 0014	Interface for KiddieFLOW/KiddieGAIT/KiddieROCKER	XLarge

ComfortKIT

Item No.	Description	Size
28418 0011	Interface for KiddieFLOW/KiddieGAIT/KiddieROCKER	Small
28418 0012	Interface for KiddieFLOW/KiddieGAIT/KiddieROCKER	Medium
28418 0013	Interface for KiddieFLOW/KiddieGAIT/KiddieROCKER	Large
28418 0014	Interface for KiddieFLOW/KiddieGAIT/KiddieROCKER	XLarge

Replacement straps

Item No.	Description	Size
28368 0011	Strap Set for KiddieFLOW/KiddieGAIT/KiddieROCKER	Small
28368 0012	Strap Set for KiddieFLOW/KiddieGAIT/KiddieROCKER	Medium
28368 0013	Strap Set for KiddieFLOW/KiddieGAIT/KiddieROCKER	Large/ XLarge

KiddieGAIT® SoftSHELL™ YOUTH

The SoftSHELL for KiddieGAIT® comes in two different versions depending on size. The youth sizes have the outer SoftSHELL material combined with the SoftKIT Interface - all in one with two straps with D-rings. Available in a choice of two patterns: with hearts and a grey pattern with skulls. Patterns may change over time without notice.

Item No. Grey w/Fun print	Item No. Pink w/Fun Print	Description	Size
28359 0011	28358 0011	SoftSHELL with SoftKIT	Small
28359 0012	28358 0012	SoftSHELL with SoftKIT	Medium
28359 0013	28358 0013	SoftSHELL with SoftKIT	Large
28359 0014	28358 0014	SoftSHELL with SoftKIT	XLarge



For information on Indications and Contraindications please refer to page 7. More about fitting and product selection can be found in the Allard AFO Professional Instruction.

Allard UK also offers D-Ring Straps, please see page 29 for ordering details.





KiddieGAIT® SoftSHELL™ BABY

The three smaller Baby Sizes have a slightly different construction. The shell is a separate cover that should be combined with a SoftKIT. The simple and circular closure provides a firm cover over the calf.

Item No. Blue w/Fun Print	Item No. Pink w/Fun Print	Description	Size
28388 0008	28389 0008	SoftSHELL w/o SoftKIT	BabySmall
28388 0009	28389 0009	SoftSHELL w/o SoftKIT	BabyMedium
28388 0010	28389 0010	SoftSHELL w/o SoftKIT	BabyLarge



Baby size SoftKIT

Item No.	Description	Size
28397 0008	SoftKIT	BabySmall
28397 0009	SoftKIT	BabyMedium
28397 0010	SoftKIT	BabyLarge



Prefabricated SMO

A Surestep SMO is highly recommended to be used together with our KiddieFLOW, KiddieGAIT or KiddieROCKER to encourage heel-to-toe gait especially for patients with low tone and pronation. The Surestep Prefabricated SMO is designed to manage excessive mild to severe pronation associated with hypotonia. This SMO uses circumferential compression to stabilize the foot and ankle. The open heel allows more of the foot to “feel the floor”, which aids in sensory input and posture. For maximum function, this SMO should always be worn with suitable footwear.

Indications

Mild to severe pronation, hypotonia, triplanar instability in weight bearing, inability to stand independently, mild toe walking.

Contraindications

Hypertonia, spasticity, severe toe walking.

Weight limitations

Patients up to 22,5 kg.

Item No. Pair	Item No. Left	Item No. Right	Size	UK Shoe Size	EU Shoe Size
28740 0003	28742 1003	28742 2003	3T	2	19
28740 0004	28742 1004	28742 2004	4T	4	20
28740 0005	28742 1005	28742 2005	5T	5	21
28740 0006	28742 1006	28742 2006	6T	5.5	22
28740 0007	28742 1007	28742 2007	7T	6	23
28740 0008	28742 1008	28742 2008	8T	7	24
28740 0009	28742 1009	28742 2009	9T	8.5	26
28741 0010	28743 1010	28743 2010	10Y	9	27
28741 0011	28743 1011	28743 2011	11Y	10	28
28741 0012	28743 1012	28743 2012	12Y	11	29



Allard AFO Pre-Packaged Gait Assessment Kits



- | | | |
|-----------|------------------------|--|
| 288820000 | Ypsilon® FLOW 2½ | <ul style="list-style-type: none"> • Ready to go with SoftKIT attached! |
| 289300000 | ToeOFF® 2.0 | <ul style="list-style-type: none"> • Easy to carry for in-clinic assessment. |
| 289840000 | ToeOFF® 2½ | <ul style="list-style-type: none"> • Pre-Packaged Gait Assessment Kit |
| 289640000 | ToeOFF® FLOW 2½ | <ul style="list-style-type: none"> • Includes Sizes Small, Medium, Large |
| 289440000 | BlueROCKER® 2.0 | <ul style="list-style-type: none"> • Left and Right, boldly labelled NOT FOR RESALE. |
| 289740000 | BlueROCKER® 2½ | <ul style="list-style-type: none"> • Only to be used for patient assessment to determine correct product and size |
| 288960000 | KiddieFLOW™ | |
| 283810000 | KiddieGAIT® Baby Size | <ul style="list-style-type: none"> • We recommend the first assessment to be done in parallell bars. |
| 289050000 | KiddieGAIT® Youth Size | |
| 289090000 | KiddieROCKER® | |



Please note that these products are not returnable for credit or exchange.

Ypsilon® FLOW ½ Trial Brace

Item No. Left	Item No. Right	Description	Size
28881 1011	28881 2011	Ypsilon FLOW ½ Trial Brace	Small
28881 1012	28881 2012	Ypsilon FLOW ½ Trial Brace	Medium
28881 1013	28881 2013	Ypsilon FLOW ½ Trial Brace	Large
28881 1014	28881 2013	Ypsilon FLOW ½ Trial Brace	XLarge

ToeOFF® 2.0 Trial Brace

Item No. Left	Item No. Right	Description	Size
28921 1010	28921 2010	ToeOFF 2.0 Trial Brace Simple strap	XSmall
28921 1011	28921 2011	ToeOFF 2.0 Trial Brace Simple strap	Small
28921 1012	28921 2012	ToeOFF 2.0 Trial Brace Simple strap	Medium
28921 1013	28921 2013	ToeOFF 2.0 Trial Brace Simple strap	Large
28921 1014	28921 2014	ToeOFF 2.0 Trial Brace Simple strap	XLarge

ToeOFF® 2½ Trial Brace

Item No. Left	Item No. Right	Description	Size
28981 1010	28981 2010	ToeOFF 2½ Trial Brace Simple strap	XSmall
28981 1011	28981 2011	ToeOFF 2½ Trial Brace Simple strap	Small
28981 1012	28981 2012	ToeOFF 2½ Trial Brace Simple strap	Medium
28981 1013	28981 2013	ToeOFF 2½ Trial Brace Simple strap	Large
28981 1014	28981 2014	ToeOFF 2½ Trial Brace Simple strap	XLarge

ToeOFF®Flow 2½ Trial Brace

Item No. Left	Item No. Right	Description	Size
28961 1010	28961 2010	ToeOFF® Flow 2½ Trial Brace Simple strap	XSmall
28961 1011	28961 2011	ToeOFF® Flow 2½ Trial Brace Simple strap	Small
28961 1012	28961 2012	ToeOFF® Flow 2½ Trial Brace Simple strap	Medium
28961 1013	28961 2013	ToeOFF® Flow 2½ Trial Brace Simple strap	Large
28961 1014	28961 2014	ToeOFF® Flow 2½ Trial Brace Simple strap	XLarge

BlueROCKER® 2.0 Trial Brace

Item No. Left	Item No. Right	Description	Size
28941 1010	28941 2010	BlueROCKER® Trial Brace Simple strap	XSmall
28941 1011	28941 2011	BlueROCKER® Trial Brace Simple strap	Small
28941 1012	28941 2012	BlueROCKER® Trial Brace Simple strap	Medium
28941 1013	28941 2013	BlueROCKER® Trial Brace Simple strap	Large
28941 1014	28941 2014	BlueROCKER® Trial Brace Simple strap	XLarge

Please note that these products are not returnable for credit or exchange.





BlueROCKER® 2½ Trial Brace

Item No. Left	Item No. Right	Description	Size
28971 1010	28971 2010	BlueROCKER® Trial Brace	Simple strap XSmall
28971 1011	28971 2011	BlueROCKER® Trial Brace	Simple strap Small
28971 1012	28971 2012	BlueROCKER® Trial Brace	Simple strap Medium
28971 1013	28971 2013	BlueROCKER® Trial Brace	Simple strap Large
28971 1014	28971 2014	BlueROCKER® Trial Brace	Simple strap XLarge



KiddieFLOW™ Trial Brace

Item No. Left	Item No. Right	Description	Size
28894 1011	28894 2011	KiddieFLOW Trial Brace	Small
28894 1012	28894 2012	KiddieFLOW Trial Brace	Medium
28894 1013	28894 2013	KiddieFLOW Trial Brace	Large
28894 1014	28894 2014	KiddieFLOW Trial Brace	XLarge



KiddieGAIT® Trial Brace

Item No. Left	Item No. Right	Description	Size
28382 1008	28382 2008	KiddieGAIT BABY Trial Brace	BabySmall
28382 1009	28382 2009	KiddieGAIT BABY Trial Brace	BabyMedium
28382 1010	28382 2010	KiddieGAIT BABY Trial Brace	BabyLarge
28904 1011	28904 2011	KiddieGAIT Trial Brace	Small
28904 1012	28904 2012	KiddieGAIT Trial Brace	Medium
28904 1013	28904 2013	KiddieGAIT Trial Brace	Large
28904 1014	28904 2014	KiddieGAIT Trial Brace	XLarge



KiddieROCKER® Trial Brace

Item No. Left	Item No. Right	Description	Size
28908 1011	28908 2011	KiddieROCKER Trial Brace	Small
28908 1012	28908 2012	KiddieROCKER Trial Brace	Medium
28908 1013	28908 2013	KiddieROCKER Trial Brace	Large
28908 1014	28908 2014	KiddieROCKER Trial Brace	XLarge

Straps (All products)

Replacement strap kits comprise upper and lower straps.

Item No.	Description	Size
28373 0008	Strap Set KiddieGAIT, black	BabySmall
28373 0009	Strap Set KiddieGAIT, black	BabyMedium
28373 0010	Strap Set KiddieGAIT, black	BabyLarge
28368 0011	Strap Set KiddieGAIT, black	Small
28368 0012	Strap Set KiddieGAIT, black	Medium
28368 0013	Strap Set KiddieGAIT, black	Large/XLarge
28369 0011	Strap Set KiddieGAIT, black. With D-ring	Small
28369 0012	Strap Set KiddieGAIT, black. With D-ring	Medium
28369 0013	Strap Set KiddieGAIT, black. With D-ring	Large
28760 0010	Strap Set for ToeOFF/BlueROCKER 2.0 & 2½	XSmall
28760 0011	Strap Set for ToeOFF/BlueROCKER 2.0 & 2½	Small
28760 0012	Strap Set for ToeOFF/BlueROCKER 2.0 & 2½	Medium
28760 0013	Strap Set for ToeOFF/BlueROCKER 2.0 & 2½	Large
28760 0014	Strap Set for ToeOFF/BlueROCKER 2.0 & 2½	XLarge
28761 0010	Strap Set for ToeOFF/BlueROCKER 2.0 & 2½ with D-ring	XSmall
28761 0011	Strap Set for ToeOFF/BlueROCKER 2.0 & 2½ with D-ring	Small
28761 0012	Strap Set for ToeOFF/BlueROCKER 2.0 & 2½ with D-ring	Medium
28761 0013	Strap Set for ToeOFF/BlueROCKER 2.0 & 2½ with D-ring	Large
28761 0014	Strap Set for ToeOFF/BlueROCKER 2.0 & 2½ with D-ring	XLarge
28768 0011	Strap Set for ToeOFF Short	Small
28768 0012	Strap Set for ToeOFF Short	Medium
28768 0013	Strap Set for ToeOFF Short	Large



Vertical Pads

Vertical pad, designed to create an open channel for the tibial crest when extra pressure relief is necessary for optimum patient comfort. They include pressure-sensitive backing for easy application. Intended as replacements for the originals supplied with each SoftKit.

Item No.	Description	Size
28753 0011	Vertical Tibia Pad for 2.0	Small
28753 0013	Vertical Tibia Pad for 2.0	Large

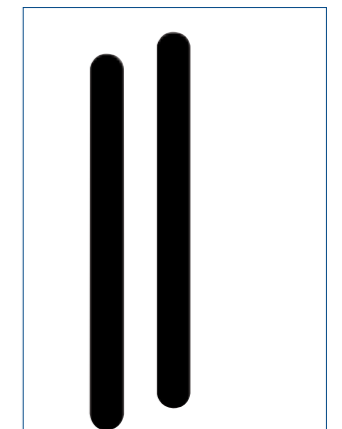

Please note that these products are not returnable for credit or exchange.



SoftKIT™

Every Allard AFO (excluding Ypsilon Flow ½) should have a soft interface between the orthosis and tibial crest. We offer two solutions: SoftKIT™ and ComfortKIT™. We offer three types of SoftKIT™ which suit the various Allard AFO models and are available in black only.

- SoftKIT™ for ToeOFF® and BlueROCKER® Short, sized to suit the shorter strut and broader tibia plate and includes same components as SoftKIT™.
- SoftKIT™ 2.0, a more tapered interface for all adult Allard AFOs from version 2.0 onwards. This pack includes two tibia pads.
- SoftKIT™ for KiddieGAIT®/KiddeROCKER®, sized to fit baby and youth sizes and includes pre-cut MikroFIX™ tabs necessary to attach the SoftKIT™ to the AFO.

Item No. Black	Description	Size
28397 0008	SoftKIT™ KiddieGAIT® Baby	BabySmall
28397 0009	SoftKIT™ KiddieGAIT® Baby	BabyMedium
28397 0010	SoftKIT™ KiddieGAIT® Baby	BabyLarge
28378 0011	SoftKIT™ KiddieFLOW™/KiddieGAIT®/KiddieROCKER®	Small
28378 0012	SoftKIT™ KiddieFLOW™/KiddieGAIT®/KiddieROCKER®	Medium
28378 0013	SoftKIT™ KiddieFLOW™/KiddieGAIT®/KiddieROCKER®	Large
28378 0014	SoftKIT™ KiddieFLOW™/KiddieGAIT®/KiddieROCKER®	XLarge
28391 0011	SoftKIT™ ToeOFF/BlueROCKER Short	Small
28391 0012	SoftKIT™ ToeOFF/BlueROCKER Short	Medium
28391 0013	SoftKIT™ ToeOFF/BlueROCKER Short	Large
28750 0010	SoftKIT™ 2.0	XSmall
28750 0011	SoftKIT™ 2.0	Small
28750 0012	SoftKIT™ 2.0	Medium
28750 0013	SoftKIT™ 2.0	Large
28750 0014	SoftKIT™ 2.0	XLarge



MikroFIX Kits

MikroFIX Kits are pre-cut shapes used to adhere the SoftKIT or ComfortKIT to the products. They include pressure-sensitive backing for easy application. Intended as replacements for the originals supplied with SoftKIT and ComfortKIT.

Item No.	Description	Size
28379 0011	MikroFIX for SoftKIT KiddieGAIT/KiddieROCKER	Small
28379 0012	MikroFIX for SoftKIT KiddieGAIT/KiddieROCKER	Medium
28379 0013	MikroFIX for SoftKIT KiddieGAIT/KiddieROCKER	Large/XLarge
28419 0000	MikroFIX for KiddieGAIT/KiddieROCKER wings only	One Size
28752 0011	MikroFIX for SoftKIT/ComfortKIT 2.0	XSmall/Small
28752 0013	MikroFIX for SoftKIT/ComfortKIT 2.0	Medium/Large/XLarge
28754 0000	MikroFIX for SoftKIT/ComfortKIT 2.0	One size
28356 0011	MicroFIX for SoftKIT SHORT	Small
28356 0012	MicroFIX for SoftKIT SHORT	Medium
28356 0013	MicroFIX for SoftKIT SHORT	Large
28357 0000	MicroFIX Ears for SHORT	One size

ComfortKIT™

ComfortKIT™ our premium interface for the Allard AFO. It is recommended for patients who require added cushioning and a more intimate fit due to the shape of the tibia, skin condition and activity level. We offer two versions of ComfortKIT™ which are available in black only:

- ComfortKIT™ 2.0, a more tapered interface, which is compatible with all adult Allard AFOs from version 2.0 onwards. The pack does not include MikroFIX™ tabs as these are pre-applied on later versions of all adult Allard AFOs.
- ComfortKIT™ for KiddieFLOW™/KiddieGAIT®/KiddeROCKER®, sized to fit youth sizes and includes pre-cut MikroFIX™ tabs necessary to attach the ComfortKIT™ to the AFO.

Item No. Black	Description	Size
28418 0011	ComfortKIT™ KiddieGAIT®/KiddieROCKER®	Small
28418 0012	ComfortKIT™ KiddieFLOW™/KiddieGAIT®/KiddieROCKER®	Medium
28418 0013	ComfortKIT™ KiddieFLOW™/KiddieGAIT®/KiddieROCKER®	Large
28418 0014	ComfortKIT™ KiddieFLOW™/KiddieGAIT®/KiddieROCKER®	XLarge
28751 0010	ComfortKIT™ 2.0	XSmall
28751 0011	ComfortKIT™ 2.0	Small
28751 0012	ComfortKIT™ 2.0	Medium
28751 0013	ComfortKIT™ 2.0	Large
28751 0014	ComfortKIT™ 2.0	XLarge

Non-Skid Interface

Non-Skid interface is designed to be used in between an AFO and a plastic foot orthosis to prevent friction and abrasion of carbon composite footplates. Especially useful for paediatric patients that gather sand inside their shoes while playing.

Item No.	Description	Size
28411 0000	Non-Skid Interface, black	135 mm x 1m roll, Roll





Hip Orthoses



S.W.A.S.H.[®]

Increase Levels of Function

What makes SWASH[®] unique to other hip orthoses is that it offers controlled variable abduction. It is engineered with a complex series of angles to maintain good hip alignment as the uprights follow the pathways of motion of the femurs.

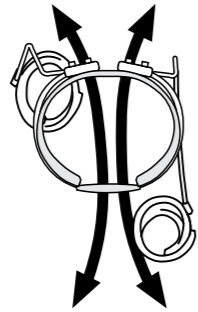

While standing or walking, SWASH[®] provides just enough abduction to prevent scissoring and medial femoral rotation. As the hips are flexed to assume the sitting position, it automatically further abducts the hips to create a tripod base for enhanced sitting stability and more upright posture.

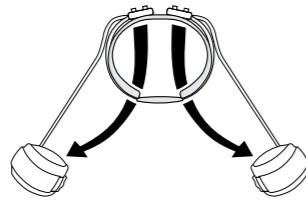

The most visible benefits of the SWASH[®] are readily apparent by improvements in sitting and standing posture and stability, and for the ambulatory user, improvement in gait. However, perhaps the most important benefit the SWASH[®] offers is guidance for hip alignment.

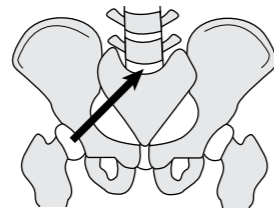

With

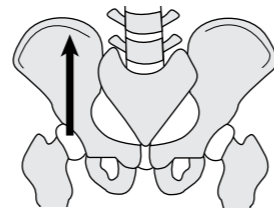

Without

S.W.A.S.H.[®] STEADY

(Replaces previous SWASH Classic)

- Plastic pelvic section extends from L2/L3 to the coccyx, providing maximum torso support for candidates with flaccidity or very limited trunk control
- Single strap fixed front closure to secure torso support
- Increased posterior and side support
- "Childproof" thigh cuff closure
- 6mm diameter uprights for size 1, 8mm uprights for size 2, 3, 4



S.W.A.S.H.[®] GO

(Replaces previous SWASH Low Profile II)

- Anatomically shaped metal pelvic section rests over the pelvis and is secured in position by attaching to a small plastic reinforced abdominal pad
- Double strap front closure allows symmetrical application
- 8 mm diameter uprights in all sizes - extra strong for extra high tone
- Interchangeable thigh cuff sizes
- Overlap design thigh cuff closure for easy application and removal
- Contoured posterior joints reduce interference with posterior walkers and other standing/walking/sitting aids



Two options for upright selection

More abduction in sitting

Increased abduction offers maximum opportunity for muscle lengthening in the sitting position, and is also recommended when there is need to influence the trunk toward more spinal extension.



Less abduction in sitting

Reduced abduction better accommodates wheelchairs with narrow seat structures and is better tolerated by children with tight adductor muscles.

Measure:	Size	Sizes Available		Circumference	
		STEADY	GO	Adjustment Range	
SWASH® STEADY - At level of the natural waist for maximum trunk stability.	1	✓	✓	400-465mm	15 ¼-18 ¼in
	2	✓	✓	460-550mm	18-21 ¾in
	3	✓	✓	540-630mm	21 ¼-24 ¾in
	4	✓	✓	620-720mm	24 ½-28 ¾in
	5	N/A	✓	710-810mm	28-32in
	6	N/A	✓	800-900mm	31 ½-35 ½in
SWASH® GO - At the level of the ASIS. Ideal is to fit the orthosis at mid-pelvic girdle to obtain good pelvic stability.	1	✓	✓	210-250mm	8 ¼-9 ¾in
	2	✓	✓	250-290mm	9 ¾-11 ½in
	3	✓	✓	290-330mm	11 ½-13in
	4	✓	✓	330-380mm	13-15in
	5	✓	✓	380-440mm	15-17 ¼in
	6	✓	✓	440-500mm	17 ¼-19 ½in

Measure:	Size	Sizes Available		Circumference	
		STEADY	GO	Adjustment Range	
THIGH CUFFS Measure at distal thigh, just proximal to the condyles. Ideal is to fit the cuffs as distal as possible without creating pressure or interference in the popliteal area. However, pressure on the thorax, excessive spinal flexion, or discomfort due to hamstring tightness, may be relieved by moving the cuffs up 1 - 3 inches.	1	✓	✓	210-250mm	8 ¼-9 ¾in
	2	✓	✓	250-290mm	9 ¾-11 ½in
	3	✓	✓	290-330mm	11 ½-13in
	4	✓	✓	330-380mm	13-15in
	5	✓	✓	380-440mm	15-17 ¼in
	6	✓	✓	440-500mm	17 ¼-19 ½in

Measure:	Size	Upright Diameter		Waist to Mid-Patella	
		STEADY	GO		
UPRIGHTS Measure waist to mid-patella. At final fitting, should be shortened to level of distal thigh cuff padding. 115° = narrow sitting base 123° = wide sitting base	1	6mm	8mm	310mm	12 ¼in
	2	8mm	8mm	375mm	14 ¾in
	3	8mm	8mm	440mm	17 ¼in
	4	8mm	8mm	480mm	19in
	5	8mm	8mm	540mm	21 ¼in
	6	8mm	8mm	600mm	23 ½in

Size	Component	PELVIC STEADY	PELVIC GO	CUFFS	UPRIGHTS 115 Deg.	UPRIGHTS 123 Deg.
1	STEADY	288520001		288540601	288550601	288560601
1	GO		288530001	288540801	288550801	288560801
2	STEADY & GO	288520002	288530002	288540802	288550802	288560802
3	STEADY & GO	288520003	288530003	288540803	288550803	288560803
4	STEADY & GO	288520004	288530004	288540804	288550804	288560804
5	STEADY & GO	N/A	288530005	288540805	288550805	288560805
6	STEADY & GO	N/A	288530006	288540806	288550806	288560806

NOTE: Color Coding indicates interchangeable components.

Assembly tools required. Please refer to our Fitting Manual for assistance with sizing and fitting.

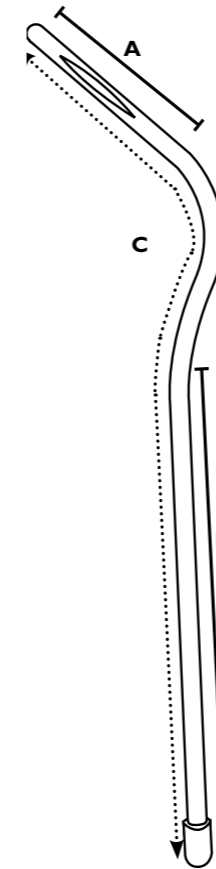

Upright lengths

Size	Proximal Length A, mm	Distal Length B, mm	Total Length C, mm
1	63	175	310
2	80	215	375
3	80	280	440
4	80	320	480
5	90	370	540
6	100	420	600

Plastic circumference

Size	Top in mm	Bottom in mm
1	230	210
2	270	250
3	310	290
4	360	340
5	390	370
6	460	420

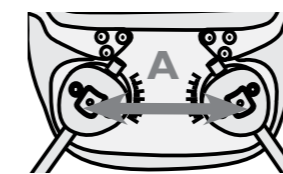
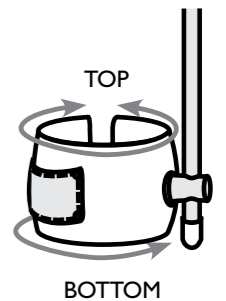

Pelvic Section - Distance Between Joint Centers

Size	STEADY A, in mm	GO A, in mm
1	82	82
2	90	90
3	105	105
4	120	120
5	N/A	130
6	N/A	150

Measurements are taken on flat plate before bending.

S.W.A.S.H.[®]

STEADY & GO Replacement Components

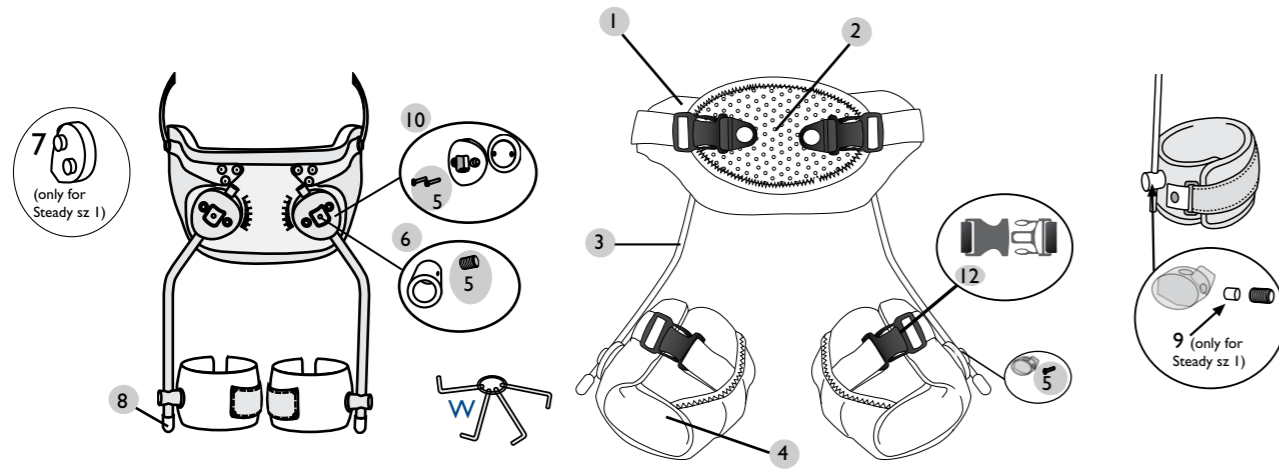

No.	Description	Unit	STEADY	GO
1	Pelvic Padding with abdominal Pad	1 set	28857	28858
2	Abdominal Pad	1 pcs	28860	28860
3	Upright 6 mm 115°, size 1 only	Pair	28855	
3	Upright 8 mm 115°	Pair	28855	28855
3	Upright 6 mm 123°, size 1 only	Pair	28856	
3	Upright 8 mm 123°	Pair	28856	28856
4	Thigh Cuffs Padding	Pair	28859	28859
5	Screw Kit, size 1		28861	
5	Screw Kit, size 2 - 6		28861	28861
6	Clamp Ring Set, size 1	2 pcs	28862	
6	Clamp Ring Set, size 2 - 6	2 pcs	28862	28862
7	Boss Cover, size 1	2 pcs	28863	
8	Upright End Cover, size 1	2 pcs	28864	
8	Upright End Cover, size 2 - 6	10 pcs	28864	28864
9	Brass Bushing, size 1	10 pcs	28865	
10	Hip Joint Set, size 1	2 pcs	28866	
10	Hip Joint Set, size 2 - 6	2 pcs	28866	28867
11	Allen Wrench Key Set	1 set	28868	28868
12	Buckles 25 mm, for size 1 - 3	2 pcs	28869	28869
12	Buckles 38 mm, for size 4 - 6	2 pcs	28869	28869



Contracture Management

MultiMotion

The Next Generation

We would like to introduce to you the next generation of our MultiMotion dynamic corrective joints. First of all, there is its eye-catching, clean design and modern appearance. The expressive details make this hinge a worthy successor, but that's not all. Hidden from view, this dynamic joint houses a variety of new features which are accentuated, among other features, by the use of high-quality materials.

Our dynamic corrective joints are designed for the treatment of patients with limited joint mobility and provide safe, efficient and appropriate treatment of contractures due to neurological and orthopedic conditions. The corrective joint can be used in orthoses for all age groups.

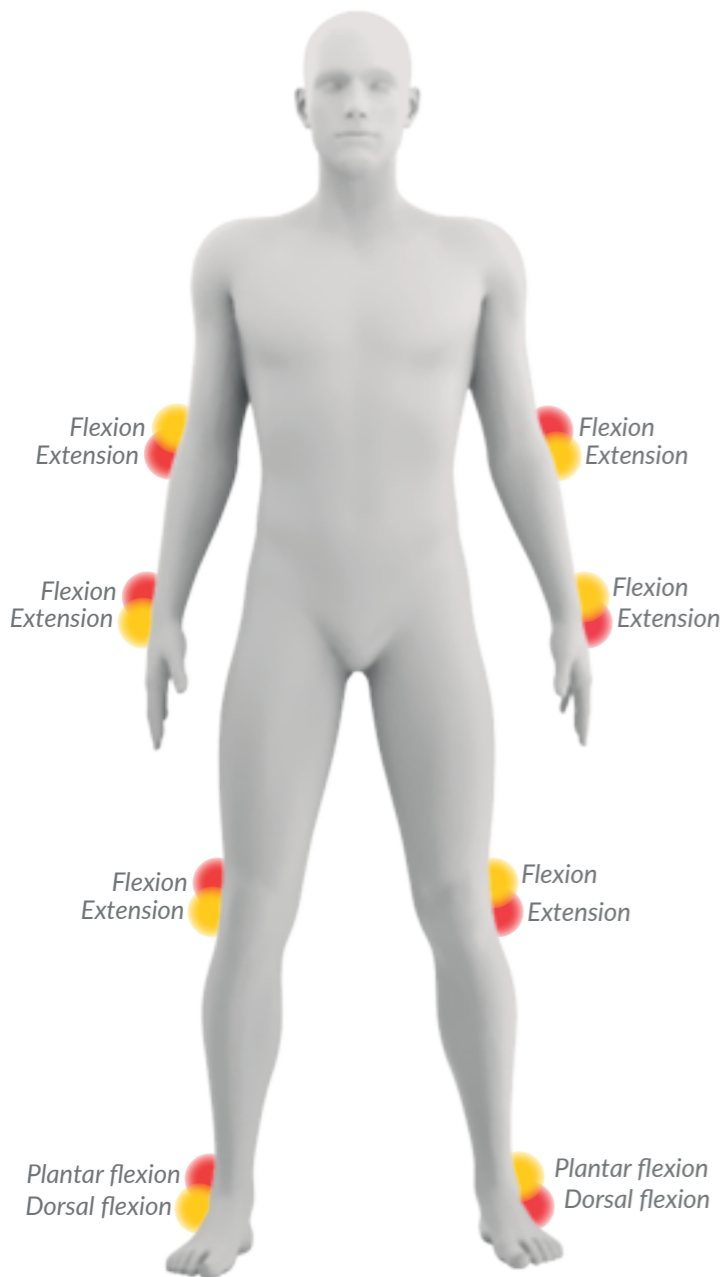

The functionality of the MultiMotion corrective joint is based on the LLPS (Low Load Prolonged Stretch) principle. This process of gradual, precise and evenly applied tension promotes the growth of the shortened tissue and increases joint mobility. The application of a low but sustained corrective force lengthens the affected tissue, improving the range of motion of the joint. Treatment of the contracture can be done in both flexion or extension with the very same joint. The selection of these is easily adjusted by flipping the spring cassette from the red (Fig. 1) to the yellow (Fig. 2) side, or vice versa. The correct setting depends on the body side and the specific joint to which the joint is applied.

MultiMotion Joint - changing the direction of force



MultiMotion

Dynamic Corrective Joint

Intended use: treatment of dynamically correctable contractures



Neurological indications

- Apoplexy (CVA)
- Cerebral palsy
- Cranial Brain Trauma
- Dystrophy
- Multiple sclerosis
- Paresis
- Spina bifida

Contraindications

- Abnormal arthrokinematics
- Ankylosis
- Arthrodesis
- Fibrosis
- Ossification

Orthopedic indications

- Amputation
- Fracture
- Ligament rupture
- Post-op after placement of endoprotheses, etc.

Application

The corrective joint facilitates efficient treatment of dynamically correctable contractures according to the LLPS principle.

Product functionality

The corrective joint facilitates efficient treatment of dynamically correctable contractures according to the LLPS principle.

Features

- Torque output possible in flexion or extension
- Range of Motion: +95° to -95°
- Adjustable flexion and extension stops
- Locking and unlocking possible in virtually any position
- Torque Output Infinitely adjustable
- Adjustable 0 point
- Medial and lateral access to torque output set screw
- Material: steel/stainless steel, plastic

Benefits in achieving therapy goals

- Improvement/rehabilitation of joint mobility
- Secure and step-wise joint mobilization
- Elongating/mobilizing spastic musculature
- Strengthening the musculature
- Improvement of the resting position
- Prevention of cartilage damage and ulcers



MultiMotion

Components

MultiMotion joints are available in sizes medium and large. In addition, these components come in configurations with a modular bar adapter or with integrated bars and/or T-bar. In addition to an alignment unit, various types of joint bars are available as accessories for MultiMotion. In case of a bilateral application where a companion joint is preferred for the contralateral side, a selection can be made from the FreeMotion series of freely movable joints.



Corrective Joints with modular bar adapter

Treatment recommendation
Joint: wrist / elbow / hip / knee / ankle

- Features**
- Proximal and distal connection: modular bar adapter
 - Bar width connection: 12 mm (medium), 16 mm (large)
 - Adjustable flexion and extension stops

Size chart

Item number	Size	Bar width	Joint thickness	Offset T-bar	Overall length	Joint weight	Housing diameter	Maximum spring load
69152 0000	medium	12 mm	19 mm	-	124 mm	125 g	36 mm	4,1 Nm
69140 0000	large	16 mm	24 mm	-	144 mm	268 g	50 mm	8,4 Nm

Corrective Joints with modular bar adapter & T-Bar

Treatment recommendation
Joint: wrist / ankle

- Features**
- Proximal connection: modular bar adapter
 - Bar connection width: 12 mm (medium), 16 mm (large)
 - Distal connection: T-bar
 - T-bar length: 155 mm (medium), 185 mm (large)
 - Adjustable flexion and extension stops

Size chart

Item number	Size	Bar width	Joint thickness	Offset T-bar	Axis to bottom	Joint weight	Housing diameter	Maximum spring load
69159 0000	medium	12 mm	19 mm	10 mm	56 mm	154 g	36 mm	4,1 Nm
69147 0000	large	16 mm	24 mm	10 mm	73 mm	303 g	50 mm	8,4 Nm

Corrective Joints with integrated bars

Treatment recommendation
Joint: wrist / elbow / ankle

- Features**
- Proximal and distal: Integrated bars
 - Proximal and distal bar length: 270 mm
 - Adjustable flexion and extension stops

Size chart

Item number	Size	Bar width	Joint thickness	Offset T-bar	Overall length	Joint weight	Housing diameter	Maximum spring load
69149 0000	medium	12 mm	19 mm	-	540 mm	210 g	36 mm	4,1 Nm
69148 0000	large	16 mm	24 mm	-	540 mm	405 g	50 mm	8,4 Nm

Corrective Joints with integrated bars & T-bar

Treatment recommendation
Joint: wrist / ankle

- Features**
- Proximal integrated bar
 - Proximal bar length: 270 mm proximal integrated bar
 - Distal connection: T-bar
 - T-bar length: 155 (medium), 175 mm (large)
 - Bar width: 12 mm (medium), 16 mm (large)
 - Adjustable flexion and extension stops

Size chart

Item number	Size	Bar width	Joint thickness	Offset T-bar	Axis to bottom	Joint weight	Housing diameter	Maximum spring load
69151 0000	medium	12 mm	19 mm	10 mm	56 mm	125 g	36 mm	4,1 Nm
69150 0000	large	16 mm	24 mm	10 mm	73 mm	268 g	50 mm	8,4 Nm

Accessories

MultiMotion alignment unit

This alignment unit facilitates the production of the orthosis and is a convenient, high quality tool that can be used multiple times for the proper alignment of the MultiMotion joints on the cast.

Size chart

Item number	UOM	Description
69167 0000	each	T-Bar
69166 0000	set	Alignment unit

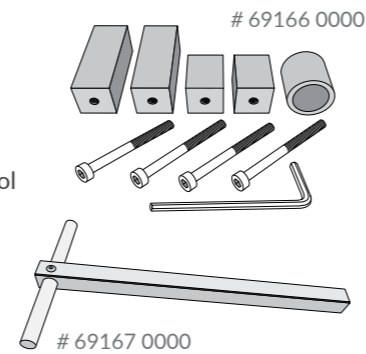

Joint Bars

All bars are supplied pre-drilled for optimum attachment. The bars have a high rigidity and are available in two different sizes and several configurations.

Features

- Material: Aluminum

Size chart

Item number	Size	Bar Length	Bar Width	Bar Thickness	Model
69160 0000	small	200 mm	12 mm	3,2 mm	Straight
69162 0000	small	350 mm	12 mm	3,2 mm	Offset
69164 0000	small	150 mm	12 mm	3,2 mm	T-Bar
69161 0000	medium	200 mm	16 mm	4,0 mm	Straight
69163 0000	medium	450 mm	16 mm	4,0 mm	Offset
69165 0000	medium	150 mm	16 mm	3,2 mm	T-Bar

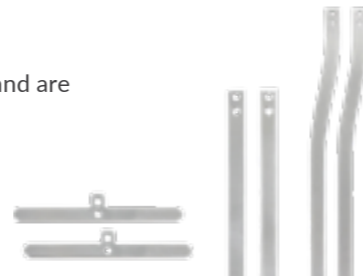

FreeMotion Free Movable Joints

FreeMotion represents a product series of single-axis free motion joints, suitable for individual orthopedic devices of the upper and lower extremity for children, adolescents and adults. The joint can be used individually, but is also an ideal companion joint in combination with the MultiMotion corrective joint.

Intended use: these free motion joints can be used as an individual joint or as a companion joint on the contra lateral side of the affected joint to improve the torsional rigidity of the orthosis.

Features

- Configurations:
- Proximal and distal modular bar adapter ⁽¹⁾
- Proximal bar adapter, distal with T-Bar ⁽²⁾
- Proximal integrated bar, distal with T-Bar ⁽³⁾
- Proximal and distal integrated bars ⁽⁴⁾
- Range of motion: +120° tot -120°
- Material: stainless steel



Size chart

Nr.:	Item number	Size	Side	Length	Width	Height	Weight	Ø Joint head	Offset T-Bar	Axis to bottom
1	69697 0000	small	universal	93 mm	12 mm	11 mm	40 g	18 mm	-	46 mm
2	69698 0000	small	universal	97 mm	12 mm	11 mm	72 g	18 mm	10 mm	50 mm
3	69695 0000	small	universal	400 mm	12 mm	11 mm	102 g	18 mm	-	200 mm
4	69699 0000	small	universal	250 mm	12 mm	11 mm	106 g	18 mm	10 mm	50 mm
1	69700 0000	medium	universal	97 mm	16 mm	11 mm	52 g	22 mm	-	48 mm
2	69703 0000	medium	universal	105 mm	16 mm	11 mm	88 g	22 mm	10 mm	55 mm
3	69696 0000	medium	universal	400 mm	16 mm	11 mm	140 g	22 mm	-	200 mm
4	69704 0000	medium	universal	260 mm	16 mm	11 mm	134 g	22 mm	10 mm	55 mm

MultiMotion

Dynamic Hip Abduction System

Intended use: Treatment of correctable adduction contractures in the hip joint

Treatment recommendation: Joint: hip (paediatrics)

This system is assembled to individually made KAFO shells and features an infinitely adjustable rotation setting. This allows the leg to be positioned in a physiologically correct manner. The adductors are elongated by the gradually applied tension which stimulates the growth of the shortened tissue and increases joint mobility.

Indications

Diplegia, spastic. Hip joint subluxation, congenital. Tetraplegia, spastic. Triplegia, spastic.

Features

Infinitely adjustable abduction force

- Adjustable flexion and extension stops
- Infinitely adjustable rotation (-40° to +40°)
- Quick release for leg shells for
- Easy donning and doffing

Product functionality

Infinitely adjustable dynamic abduction of the hip joint
Limiting the adduction or abduction of the hip joint
Locking the hip abduction and adduction
Rotation setting of the hip

Benefits in achieving therapy goals

- Improvement/rehabilitation of joint mobility
- Secure and step-wise joint mobilization
- Elongating/mobilizing spastic musculature
- Strengthening the musculature
- Improvement of the resting position
- Prevention of cartilage damage and ulcers



Ordering information

The MultiMotion dynamic hip abduction system is always assembled by two orthotic components - the corrective system joint and the abduction bars - and combined with the KEVO leg shells, they represent the complete hip abduction orthosis. Both orthotic components are available in sizes medium and large and require to be ordered separately.

Size chart - MultiMotion Dynamic Corrective Joints

Item number	Size	Bar width	Bar thickness	Joint weight	Housing diameter	Maximum spring load
69152 0000	medium	12 mm	19 mm	125 g	36 mm	4,1 Nm
69140 0000	large	16 mm	24 mm	268 g	50 mm	8,4 Nm

Size chart - MultiMotion Abduction Bars

Item number	Size	Body length
69721 0000	medium	< 105 cm
69720 0000	large	> 105 cm

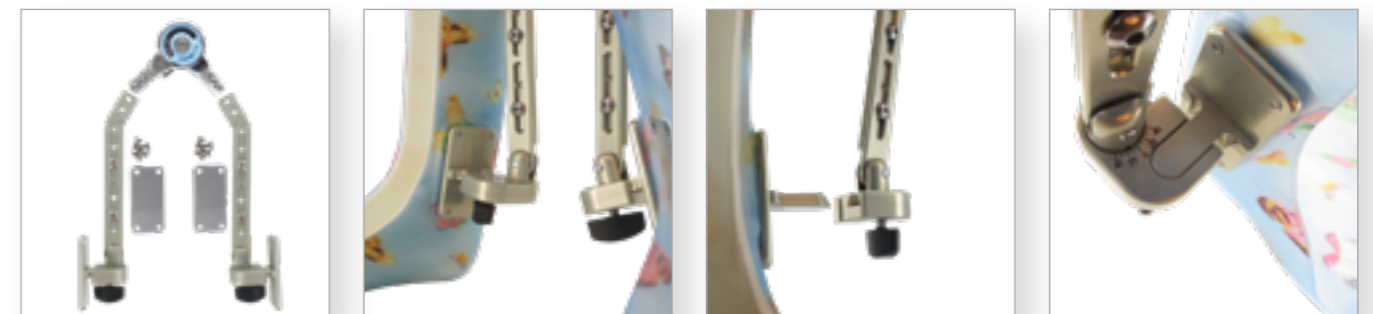

MultiStatic

Regression Joints

The MultiStatic Regression Joint enables fast and efficient static treatment of contractures primarily due to orthopaedic injuries or disease - utilizing HLBS* principles. The angle of the joint is set by an eccentric axis. This continuously adjustable static extension or flexion joint is used in orthoses for both children and adults.

Intended use: Static treatment of correctable contractures

* HLBS = High Load Brief Stretch

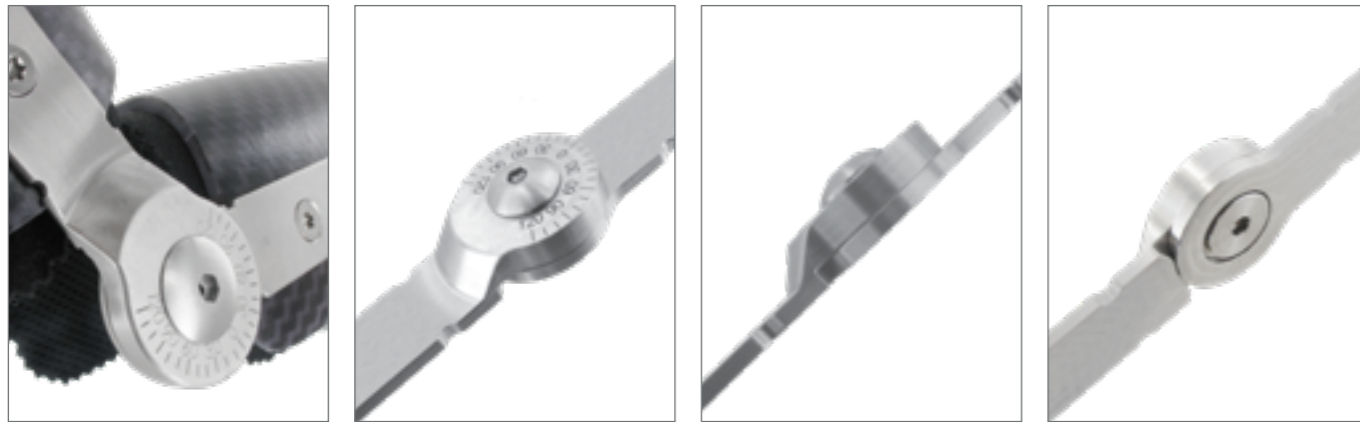

Benefits in achieving therapy objectives

- Range of motion: +120° tot -120°
- Improvement of the resting posture

Product function

- Continuous adjustable static Extension or Flexion of the joint

Features

- Easy angle adjustment due to optimally positioned joint axis
- Can be used in Flexion and Extension
- Range of motion from +120o to -120o
- Joint head and axle hardened
- Integrated bars
- Material: stainless steel

The MultiStatic regression joint is suitable for the static treatment of contractures that have a neurological or orthopaedic origin.

Neurological indications

- Apoplexie (CVA)
- Cerebral palsy
- Cranial Brain Trauma
- Dystrophy
- Multiple sclerose
- Status after paraplegia
- Spina Bifida

Orthopedic indications

- Amputation
- Fracture
- Status after ligament rupture
- Status after joint surgery

Contraindications

- Structural contractures such as:
- Ankylosis
- Fibrosis
- Ossification
- Deformation of muscles and bones
- Poor blood circulation

Size chart

Art. no.	UOM	Size	Side	Length	Width	Height	Weight	Ø Joint Head
69689 0000	each	X-small	universal	100 mm	9 mm	6,5 mm	14 g	11 mm
69690 0000	each	small	universal	400 mm	12 mm	8,5 mm	83 g	19 mm
69691 0000	each	medium	universal	400 mm	16 mm	9,5 mm	121 g	25 mm
69692 0000	each	large	universal	400 mm	19 mm	10,5 mm	151 g	30 mm



Dynamic Textile Orthoses

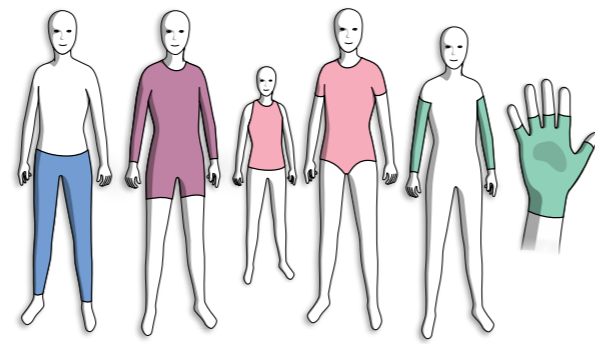

Elements Body

A meticulously crafted range of Made-to-Measure (MTM) medical device class 1 dynamic textile orthoses, designed to meet the stringent requirements of MDR 2017/745. Our garments feature carefully selected fabrics, produced, and certified in accordance with OEKO-TEX standard 100, product class II.

Our textile orthoses leverage the therapeutic benefits of dynamic compression, delivering sensory and proprioceptive feedback that is crucial for the ideal therapeutic outcome. The base material of Elements Body applies targeted compression to the body, simultaneously increasing sensory and proprioceptive feedback and accommodating natural movement. Biomechanical reinforcements are strategically positioned to further influence normal movement, soft tissue dynamics, and joint alignment, fostering stability,

Key Features of Elements Body:

Constant and consistent feedback

Provides sustained sensory and proprioceptive input.

Motor learning and neural integration

Augments the potential for motor learning and neural integration.

External stabilisation, alignment, and resistance

- Improves postural control and proximal stability
- Enhances quality of movement and tone.
- Promotes fluidity of movement and tone management.

Reduction of involuntary movements

Observed to mitigate involuntary movements effectively.

Diaphragmatic support

Provides crucial diaphragmatic support, leading to improved breathing and vocalisation.

Enhanced carer handling and transferring

Facilitates improved handling and transferring by caregivers.



Our specialised garments have demonstrated positive outcomes in the following conditions:

- Cerebral Palsy:** Tailored support for individuals with cerebral palsy.
- Acquired Brain:** Injury Addressing tone management needs post-acquired brain injury.
- Acquired Spinal Cord:** Injury Providing targeted intervention for postural management after spinal cord injury.
- Cerebellar Ataxia:** Tailored support to manage tone challenges associated with cerebellar ataxia.
- Athetosis:** Effective intervention for individuals experiencing involuntary movements.
- Stroke:** Tailored to address tone issues arising post stroke.
- Multiple Sclerosis:** Offering therapeutic solutions for sensory and proprioceptive feedback, stability, and postural management
- Persistent Hypotonia:** Specially designed to provide stability and alignment for individuals with persistent hypotonia.

Item no.	Model
393000000	Vest without sleeves
393010011	Vest with short sleeves
393010013	Vest with long sleeves
393050000	Body without sleeves
393060011	Body with short sleeves
393060013	Body with long sleeves
393100011	Suit without sleeves, short legs
393100012	Suit without sleeves, ¾ legs
393100013	Suit without sleeves, long legs
393110011	Suit with sleeves, short legs
393110012	Suit with sleeves, ¾ legs
393110013	Suit with short sleeves, long legs
393120011	Suit with long sleeves, short legs
393120012	Suit with long sleeves, ¾ legs
393120013	Suit with long sleeves, long legs
393200011	Trousers with short legs
393200012	Trousers with ¾ legs
393200013	Trousers with long legs
393250000	Sock
393300000	Short glove without fingers
393310000	Short glove with fingers
393350000	Long glove without fingers
393360000	Long glove with fingers
393400000	Sleeve

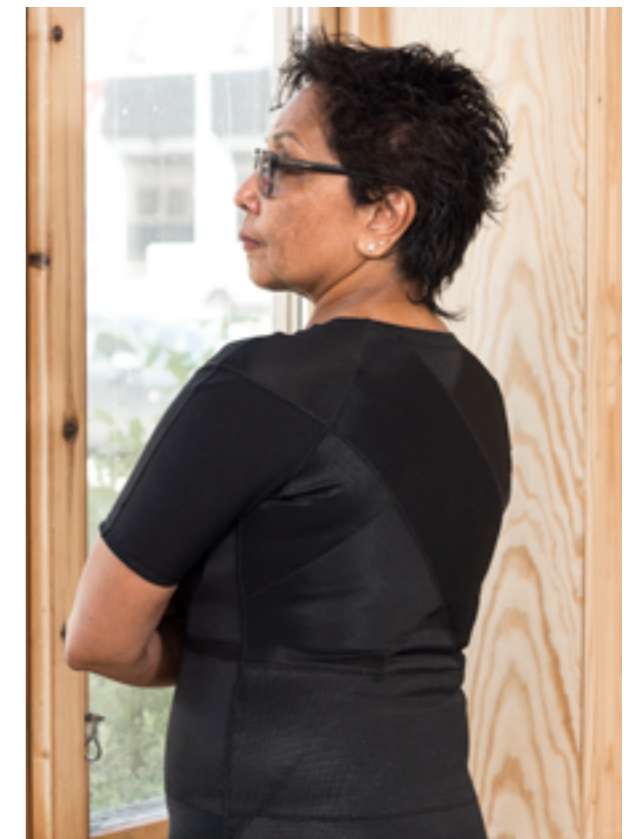

Training prerequisite: Prior to placing an order for Elements Body, prescribers are mandated to undergo training facilitated by Allard UK. This ensures that those prescribing the garments possess the requisite proficiency to make informed decisions.

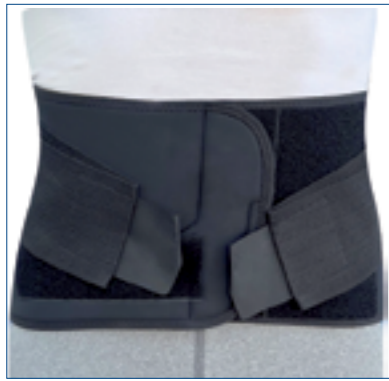

Elements Body Trial Lumbar Wrap

The Trial Lumbar Wrap is a clinical assessment aid and evaluation tool to be used in the assessment process for Elements Body. It enables the clinician to evaluate the patient's response to the application of a dynamic textile garment in preparation for a made-to-measure garment. The Trial Lumbar Wrap is intended for short-term use for a maximum of two weeks.

Item No.	Colour	Type	Pelvic Circumference
393460009	Black	XX-Small	50-60 cm
393460010	Black	X-Small	60-75 cm
393460011	Black	Small	75-90 cm
393460012	Black	Medium	90-105 cm
393460013	Black	Large	105-125 cm



Elements Body Trial Sleeve

Designed to be used in the assessment process for Elements Body MTM upper limb garments. It enables the clinician to evaluate the user's response to the application of a dynamic textile garment in preparation for a made to measure upper limb garment. The Trial sleeve is only to be used for an assessment period of 2-4 weeks to assist the clinician in identifying the clinical effectiveness and tolerance prior to the provision of an Elements Body MTM Garment.

Item No.	Size	L/R	Wrist cm	Elbow cm	Biceps cm
39344 0008	XXX-Small	Bilat.	11-12	16-18	16-18
39344 0009	XX-Small	Bilat.	12-13	18-20	18-20
39344 0010	X-Small	Bilat.	13-14	20-22	20-22,5
39344 0011	Small	Bilat.	14-15	21-23	22,5-25
39344 0012	Medium	Bilat.	14-16	22-25	24-27
39344 0013	Large	Bilat.	16-18	25-28	27-30
39344 0014	X-Large	Bilat.	18-20	28-31	30-33
39344 0015	XX-Large	Bilat.	20-22	31-34	33-37



Easy On

Easy On is intended to be used as an aid when donning an Elements Body Sleeve. Wearing the product when donning will reduce friction and make it easier to put on the orthosis. Once the Elements Body Sleeve is on, Easy On should then be removed.

Item No.	Model	Size
393570011	Easy on donning aid	Small
393570013	Easy on donning aid	Large





HyMo Textile Orthosis

A meticulously crafted, Made-to-Measure (MTM) textile orthosis designed to address the specific needs of individuals aged 10 and above diagnosed with hypermobility conditions, such as Ehlers Danlos Syndrome. Our clinical focus is on delivering targeted stabilisation and support to the soft tissue and joints, recognising hypermobility as the primary diagnosis. Prescribed by therapists and orthotists, HyMo exemplifies the intersection of clinical precision and therapeutic efficacy. Elevate your approach to hypermobility management with HyMo, where each garment is a testament to our commitment to professional excellence in textile orthotics.

Training prerequisite:

Prior to placing an order for HyMo, prescribers are mandated to undergo training facilitated by Allard UK. This ensures that those prescribing the garments possess the requisite proficiency to make informed decisions.

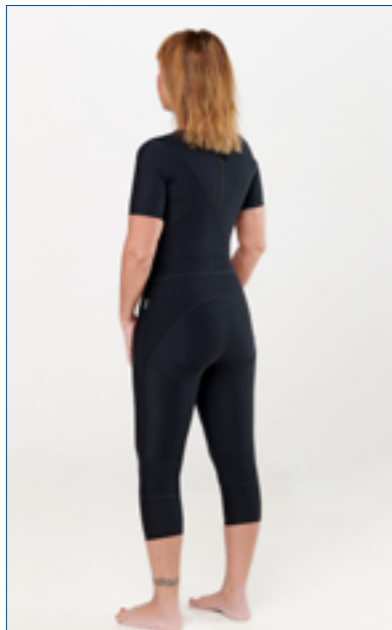

Item No.	Model	Type	Colour
39400	Body with short sleeves	Female	Black
39401	Body with short sleeves	Male	Black
39402	Body with long sleeves	Female	Black
39403	Body with long sleeves	Male	Black
39408	Body with 3/4 sleeves	Female	Black
39409	Body with 3/4 sleeves	Male	Black
39404	Trousers with short legs	Female	Black
39405	Trousers with short legs	Male	Black
39406	Trousers with long legs	Female	Black
39407	Trousers with long legs	Male	Black
39410	Trousers with 3/4 legs	Female	Black
39411	Trousers with 3/4 legs	Male	Black

Suitable for individuals aged 10 and above!

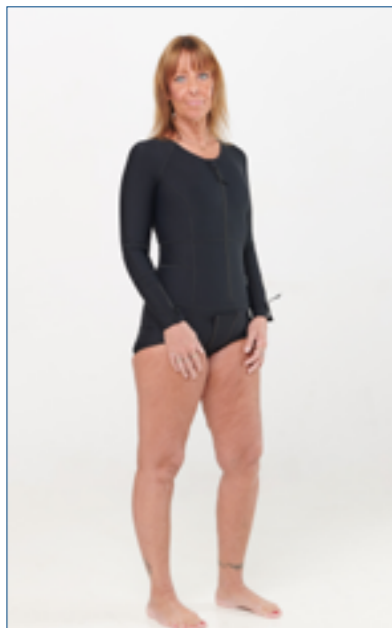

Wrist and Thumb Orthoses



S.O.T Thumb Orthosis

Positions the thumb in an optimal resting position. A Unique Orthotic Solution for Thumb and Palm This orthosis is designed to restrict movement at the CMC and MCP joints of the thumb, support the arches of the hand, whilst positioning the thumb in an optimal position for management of pain, joint stability and soft tissue length, that could lead to mal-alignment or subluxation of the joint.

Features

- The orthosis has an adjustable aluminium core that can easily be shaped to fit individual anatomy.
- The orthosis can be adjusted as the thumb CMC position changes.
- The orthosis can be machine washed with cover attached at 40°C.
- The smooth design makes it an excellent alternative to custom made thumb orthosis.

Intended use

Osteoarthritis*, rheumatoid arthritis, adduction contracture of the thumb, overload injury of the CMC joint.

*OA in CMC region, stages 1-4. At OA in stage 4, the scaphoid is also involved. The thumb support should then be combined with a wrist orthosis. Eaton and Littler Classification of Basilar Thumb Arthritis.

Item No.	Description	Side	Size	MCP Width**	Length ** (from wrist to fingertip)
28720 1011	S.O.T. Thumb Orthosis*	Left	Small	≤ 7,5 cm	≤ 18,5 cm
28720 1012	S.O.T. Thumb Orthosis*	Left	Medium	≤ 8,5 cm	≤ 20 cm
28720 1013	S.O.T. Thumb Orthosis*	Left	Large	≤ 9 cm	≤ 21 cm
28720 2011	S.O.T. Thumb Orthosis*	Right	Small	≤ 7,5 cm	≤ 18,5 cm
28720 2012	S.O.T. Thumb Orthosis*	Right	Medium	≤ 8,5 cm	≤ 20 cm
28720 2013	S.O.T. Thumb Orthosis*	Right	Large	≤ 9 cm	≤ 21 cm
28721 1011	Extra cover	Left	Small		
28721 1012	Extra cover	Left	Medium		
28721 1013	Extra cover	Left	Large		
28721 2011	Extra cover	Right	Small		
28721 2012	Extra cover	Right	Medium		
28721 2013	Extra cover	Right	Large		

* complete orthosis with one cover

** Relation between MCP width and wrist to fingertip length can vary. Regard the size interval only as a guide.

S.O.T Resting Splint

Many patients who have experienced a stroke, over time may get a variety of complications, such as spasticity, paralysis, pain, loss of sensation, decreased proprioception and oedema of the hand and arm. These complications can cause a reduction of mobility in the hand and eventually contractures may develop, therefore, it is important to start with orthotic treatment, along with hand therapy at an early stage, before spasticity is established, and contractures occur. S.O.T is a smooth, lightweight resting splint that has an aluminium core that allows adjustment to the desired position. The aluminium core is embedded into polyethylene foam and covered with fabric. The brace is delivered in a resting position, this position offers relaxation to the hand and may also give pain relief to the patient, it also provides a good biomechanical position that may reduce the risk of flexor shortening at the wrist and fingers. Patients suffering with rheumatoid pain may benefit from S.O.T, as it prevents the hand from falling into unfavourable painful positions. The orthosis can be adjusted into an alternative resting position.

Prevents or reduces the risk of oedema

Instead of conventional straps over the fingers, hand and arm (that can cause oedema) the S.O.T Resting Splint has a soft elasticated cover, which keeps the hand and arm in place. The pressure-distribution cover, in combination with an optimal position of the wrist and hand reduces the risk of oedema as it facilitates venous return. The material's smooth outer surface, and its low profile allow the orthosis to fit under clothing.

Accessories

A non-elastic wrist strap can be attached to the soft elasticated cover to provide firmer pressure over the wrist (for spasticity) The S.O.T finger dividers prevent skin irritations between the fingers. It also prevents ulnar/radial deviation at the fingers and contributes to a better position. Wedges can be purchased to apply a further stretch of the long finger flexors (Flexor Digitorum Profundis and Superficialis) or they can be positioned to stretch the Intrinsic muscles (Interossei and Lumbricals). The wedges can also be placed to increase the extension of the wrist without reshaping the orthosis.

Intended Use

S.O.T is a resting splint designed for patients with spasticity or paresis of the hand and arm when the objective is to maintain or increase the mobility of the upper limb.

Item no. Left	Item no. Right	Description	Side	Size	MCP Width	Wrist to finger tip
28710 1008	28710 2008	S.O.T Resting splint	L/R	XXX-Small	5,5cm	≤ 12cm
28710 1009	28710 2009	S.O.T Resting splint	L/R	XX-Small	≤ 6,5cm	≤ 14cm
28710 1010	28710 2010	S.O.T Resting splint	L/R	X-Small	≤ 7,5cm	≤ 16cm
28710 1011	28710 2011	S.O.T Resting splint	L/R	Small	≤ 7,5cm	≤ 18,5cm
28710 1012	28710 2012	S.O.T Resting splint	L/R	Medium	≤ 8,5cm	≤ 20cm
28710 1013	28710 2013	S.O.T Resting splint	L/R	Large	≤ 9 cm	≤ 21cm
28711 0009		MCP wedge	Bilat.	XX-Small	Width 65mm	Height 10mm
28711 0011		MCP wedge	Bilat.	Small	Width 75mm	Height 15mm
28711 0013		MCP wedge	Bilat.	Large	Width 90mm	Height 20mm
28712 0003		Finger divider	Bilat.	Paediatric		
28712 0005		Finger divider	Bilat.	Medium		
28712 0007		Finger divider	Bilat.	Large		
28713 0009		Extra strap	Bilat.	XXXS-XS		
28713 0012		Extra strap	Bilat.	Small-Large		
28714 1008	28714 2008	Additional cover	L/R	XXX-Small		
28714 1009	28714 2009	Additional cover	L/R	XX-Small		
28714 1010	28714 2010	Additional cover	L/R	X-Small		
28714 1011	28714 2011	Additional cover	L/R	Small		
28714 1012	28714 2012	Additional cover	L/R	Medium		
28714 1013	28714 2013	Additional cover	L/R	Large		

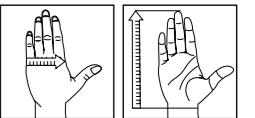

SELECTION®

Allard wrist and thumb supports are made from a material developed exclusively for Allard. Selection® Powernet, the inner textile mesh gives the material its perfect elasticity and recovery for good consistent support. Selection® Air is a thin, soft and 100% air permeable material used in selected parts of the orthosis where textile doesn't impact on function or retain heat, giving a smooth finish. Together Selection® Air and Powernet can mould to anatomical contours that allow unrestricted movement and stability. A perfect fit that is soft inside and durable outside. Elegant with high comfort.



SELECTION® Childrens Thumb

Selection® Thumb orthosis for children is elastic all the way around and the design keeps the thumb in a relaxed and pain free position.

Item No. Left	Item No. Right	Colour	Size	Wrist circumference	Palm Height	Total Length	Approx. Age
35300 1009	35300 2009	Black	XX-Small	8 - 11 cm	5 - 6 cm	11 cm	0,5 - 2 years
35300 1010	35300 2010	Black	X-Small	8 - 11cm	6 - 7 cm	13,5 cm	2 - 3 years
35300 1011	35300 2011	Black	Small	10 - 12 cm	7 - 8 cm	14,5 cm	3 - 6 years
35300 1012	35300 2012	Black	Medium	12 - 14 cm	8 - 9 cm	17 cm	6 - 11 years
35300 1013	35300 2013	Black	Large	14 - 16 cm	8 - 9 cm	17,5 cm	11 - 13 years



SELECTION® Childrens Wrist

Selection® Wrist orthosis for children is made with two stepless closures for simple adjustment. The thumb strap is adjustable. Simple aluminum stay that is easy to shape. Added colour for children.

Item No. Left	Item No. Right	Colour	Size	Wrist circumference	Palm Height	Total Length	Approx. Age
35305 1009	35305 2009	Black	XX-Small	8 - 11 cm	5 - 6 cm	11 cm	0,5 - 2 years
35305 1010	35305 2010	Black	XSmall	8 - 11cm	6 - 7 cm	13,5 cm	2 - 3 years
35305 1011	35305 2011	Black	Small	10 - 12 cm	7 - 8 cm	14,5 cm	3 - 6 years
35305 1012	35305 2012	Black	Medium	12 - 14 cm	8 - 9 cm	17 cm	6 - 11 years
35305 1013	35305 2013	Black	Large	14 - 16 cm	8 - 9 cm	17,5 cm	11 - 13 years



SELECTION® Childrens Open Wrist

Selection® Wrist orthosis for children is made with two stepless closures for simple adjustment. The thumb strap is adjustable. Simple aluminum stay that is easy to shape. Added colour for children.

Item No. Left	Item No. Right	Colour	Size	Wrist circumference	Palm Height	Total Length	Approx. Age
35306 1011	35306 2011	Black	Small	11,5 - 14 cm	7 - 8 cm	13,5 cm	3 - 6 years
35306 1012	35306 2012	Black	Medium	12 - 15,5 cm	8 - 9 cm	14,5 cm	6 - 11 years
35306 1013	35306 2013	Black	Large	14 - 16,5 cm	8 - 9 cm	17 cm	11 - 13 years

SELECTION® Wrist Short

Selection® Short is similar to Selection® Wrist Soft, low cut and without any stay on the volar side. It has the same strapping features, adjustable thumb strap and made from the smooth and well appreciated Selection material.

Item No. Left	Item No. Right	Colour	Size	Wrist circumference
35222 1010	35222 2010	Black	X-Small	< 11 cm
35222 1011	35222 2011	Black	Small	11 - 14 cm
35222 1012	35222 2012	Black	Medium	14 - 17 cm
35222 1013	35222 2013	Black	Large	17 - 20 cm
35222 1014	35222 2014	Black	XLarge	20 - 23 cm
35223 1010	35223 2010	Beige	X-Small	< 11 cm
35223 1011	35223 2011	Beige	Small	11 - 14 cm
35223 1012	35223 2012	Beige	Medium	14 - 17 cm
35223 1013	35223 2013	Beige	Large	17 - 20 cm
35223 1014	35223 2014	Beige	XLarge	20 - 23 cm



SELECTION® Thumb Soft

Selection® Soft is an elastic orthosis that align and stabilize the thumb joint and provides light support.

Item No. Black	Item No. Beige	Size	Side	Wrist circumference
35200 1010	35201 1010	X-Small	Left	< 13 cm
35200 1011	35201 1011	Small	Left	13 - 15 cm
35200 1012	35201 1012	Medium	Left	15 - 17 cm
35200 1013	35201 1013	Large	Left	17 - 20 cm
35200 1014	35201 1014	X-Large	Left	> 20 cm
35200 2010	35201 2010	X-Small	Right	< 13 cm
35200 2011	35201 2011	Small	Right	13 - 15 cm
35200 2012	35201 2012	Medium	Right	15 - 17 cm
35200 2013	35201 2013	Large	Right	17 - 20 cm
35200 2014	35201 2014	X-Large	Right	> 20 cm



SELECTION® Thumb Rigid

Selection® Rigid gives increased stability due to the non-elastic fabric around the thumb section. The design supports the muscles, keeping the thumb in a neutral position.

Item No. Black	Item No. Beige	Size	Side	Wrist circumference
35202 1010	35203 1010	X-Small	Left	< 13 cm
35202 1011	35203 1011	Small	Left	13 - 15 cm
35202 1012	35203 1012	Medium	Left	15 - 17 cm
35202 1013	35203 1013	Large	Left	17 - 20 cm
35202 1014	35203 1014	X-Large	Left	> 20 cm
35202 2010	35203 2010	X-Small	Right	< 13 cm
35202 2011	35203 2011	Small	Right	13 - 15 cm
35202 2012	35203 2012	Medium	Right	15 - 17 cm
35202 2013	35203 2013	Large	Right	17 - 20 cm
35202 2014	35203 2014	X-Large	Right	> 20 cm





SELECTION® Wrist Soft

SELECTION® Wrist Soft is our wrist support that offers medium stabilization to the wrist and hand. It has a pre-shaped removable rigid stay on the volar side and a less rigid thinner removable stay on the dorsal side. It is low cut to follow the hand's natural bend and well cut around the thumb which allows the thenar muscles to work freely. The two-piece closing system makes the orthosis easy to open and close with one hand and allows adjustment of the width of the forearm. As the lacing comes from the ulnar side, the risk of misalignment of the thumb is reduced. It has an adjustable thumb grip. Due to the construction of the material it is possible to adjust the shape slightly by trimming with scissors. The length of the orthosis is 18cm on the volar side.

Item No. Left	Item No. Right	Colour	Size	Wrist circumference	Circumference 8 cm above the wrist
35204 1010	35204 2010	Black	X-Small	< 11 cm	N/A
35204 1011	35204 2011	Black	Small	11 - 14 cm	N/A
35204 1115	35204 2115	Black	Small Plus	11 - 14 cm	18 - 21cm
35204 1012	35204 2012	Black	Medium	14 - 17 cm	N/A
35204 1125	35204 2125	Black	Medium Plus	14 - 17 cm	21 - 24 cm
35204 1013	35204 2013	Black	Large	17 - 20 cm	N/A
35204 1135	35204 2135	Black	Large Plus	17 - 20 cm	24 - 27 cm
35204 1014	35204 2014	Black	X-Large	20 - 23 cm	N/A
35204 1145	35204 2145	Black	X-Large Plus	20 - 23 cm	27 - 30 cm
35204 1015	35204 2015	Black	XX-Large	> 23 cm	N/A
35204 1155	35204 2115	Black	XX-Large Plus	> 23 cm	30 - 33 cm
35205 1010	35205 2010	Beige	X-Small	< 11 cm	N/A
35205 1011	35205 2011	Beige	Small	11 - 14 cm	N/A
35205 1115	35205 2115	Beige	Small Plus	11 - 14 cm	18 - 21cm
35205 1012	35205 2012	Beige	Medium	14 - 17 cm	N/A
35205 1125	35205 2125	Beige	Medium Plus	14 - 17 cm	21 - 24 cm
35205 1013	35205 2013	Beige	Large	17 - 20 cm	N/A
35205 1135	35205 2135	Beige	Large Plus	17 - 20 cm	24 - 27 cm
35205 1014	35205 2014	Beige	X-Large	20 - 23 cm	N/A
35205 1145	35205 2145	Beige	X-Large Plus	20 - 23 cm	27 - 30 cm
35205 1015	35205 2015	Beige	XX-Large	> 23 cm	N/A
35205 1155	35205 2155	Beige	XX-Large Plus	> 23 cm	30 - 33 cm



SELECTION® Ulnar Deviation

SELECTION® Ulnar Deviation is intended for the management of Ulnar Deviation. Corrects alignment of joints of the fingers to improve extension, strength and function of the hand. Reduces pain and joint stiffness. Ulnar deviation is likely to be a characteristic for those with various forms of inflammatory disease, such as Rheumatoid Arthritis. This may also be used for realignment and stabilization in patients with joint laxity and muscle weakness.

Item No. Left	Item No. Right	Colour	Size	Circumference MCP 2-5
35218 1010	35218 2010	Black	X-Small	13 - 16 cm
35218 1011	35218 2011	Black	Small	16 - 19 cm
35218 1012	35218 2012	Black	Medium	19 - 22 cm
35218 1013	35218 2013	Black	Large	22 - 25 cm

SELECTION® Multiopen

SELECTION® Multiopen is a semi-stable wrist support with double locking function. It can be opened up completely and secured loosely with Velcro and then pulled closed firmly with the lacing system. The patient can choose to either open it completely each time the orthosis is taken on/off or only use the lacing function.

The orthosis is low cut to follow the hand's natural creases and the thenar creases allowing the the muscles to work freely. The two-part lacing and locking in combination with Velcro enables adjustment of the width for a wider forearm. As the lacing is positioned on the ulnar side, the risk of the thumb being positioned incorrectly decreases. The orthosis has an adjustable thumb strap that attaches from the volar side and fastens on the dorsal side.

The components of the fabric make it possible to cut without fraying, using scissors, to shape for optimal fit. Made in an airy and comfortable SELECTION® material with all the functions that this entails.

The orthosis is 22cm in length, i.e. 4cm longer than a SELECTION® Soft 35204. It has an adjustable aluminium stay on the volar side which is removable.

Item No. Left	Item No. Right	Colour	Size	Wrist circumference
35209 1010	35209 2010	Black	X-Small	< 11cm
35209 1011	35209 2011	Black	Small	11 - 14 cm
35209 1012	35209 2012	Black	Medium	14 - 17 cm
35209 1013	35209 2013	Black	Large	17 - 20 cm
35209 1014	35209 2014	Black	X-Large	20 - 23 cm
35209 1015	35209 2015	Black	XX-Large	23 - 26 cm





SELECTION® Radialis Thumb

The SELECTION® range presents two new products, Radialis Finger and Radialis Thumb. These are sold as separate items to make it possible to combine them as and when required for thumb and finger extension. They have been designed to use for Radial Nerve Palsy, (dropped wrist caused by damage to the Radial Nerve) to assist functional grasp and release whilst the nerve recovers. These are intended to be combined with Selection® Wrist orthosis model numbers 35204, 35205 and 35209.

Item No. Left	Item No. Right	Colour	Size	Measure
35216 1011	35216 2011	Black	Small	3 - 4 cm
35216 1013	35216 2013	Black	Large	5 - 6 cm

Measure: Length joint centre MCP1 – joint centre IP1.



SELECTION® Radialis Finger Section

Radialis Finger component comprises two sections that change to make it easier to put on and adapt to the best fit. The Finger Part is attached to the soft plush material on the dorsal side of the orthosis. Simple to attach and comfortable to use. Can also be combined with Radialis Thumb Section.

Item No. Left	Item No. Right	Colour	Size	Measure
35217 1011	35217 2011	Black	Small	17 - 20 cm
35217 1012	35217 2012	Black	Medium	20 - 23 cm
35217 1013	35217 2013	Black	Large	23 - 27 cm

Measure: Circumference MCP 2-5



SELECTION® Wrist Rigid

SELECTION® Wrist Rigid has the same features as the soft version, but also a thumb section added for increased thumb support and stability. The thumb strap can be individually adjusted. It comes with a pre-shaped plastic stay on the palmar side and a soft narrow plastic stay on the dorsal side.

Item No. Left	Item No. Right	Size	Colour	Wrist circumference
35206 1010	35206 2010	X-Small	Black	< 11 cm
35206 1011	35206 2011	Small	Black	11 - 14 cm
35206 1012	35206 2012	Medium	Black	14 - 17 cm
35206 1013	35206 2013	Large	Black	17 - 20 cm
35206 1014	35206 2014	XLarge	Black	20 - 23 cm
35206 1015	35206 2015	XXLarge	Black	> 23 cm



Each Selection Wrist Support has the new CS-spoon inserted on the palmar side of the orthosis. It is a pre-shaped plastic spoon with flared edges at top and bottom. A soft plastic stay is also incorporated on the dorsal side of the orthosis. Both are removable. The CS-spoon is also available in packs of 10. Item number 35210.



SELECTION® Fingerloop & Fingerloop Sheet

A twin bandage that efficiently holds two fingers or more together, for the stronger finger to assist a weaker one as support, protection and/or for increased range of motion. Can also be used as a static progressive splint for increased range of motion in DIP joint. The bandage is made in 100% durable and quick-drying nylon. Welded with no seams and therefore easy to cut for a personal fit. One or more pieces can be used at the same time. The semi-prepared Fingerloop sheet which is 10 cm wide can easily be trimmed to individual straps in desired width by scissors.

Item No.	Model	Size	Width	Length	Package
35219 0000	Selection Fingerloop	One Size	2 cm	15.5 cm	5 pcs
35220 0000	Selection Fingerloop Sheet	One Size	10 cm	15.5 cm	1 Sheet



Knee Orthoses



COMBO™

Dynamic Low Profile, Lightweight, Functional Orthotic Solution for the management of genu recurvatum or chronic knee instability, accompanied with footdrop.

- Low profile and lightweight – a KAFO your patients will wear!
- Uprights easily shaped and adjusted to optimum height.
- Modular components allow you to accommodate variances in thigh and calf circumference.
- Easy to don and doff.
- Easily removed when wearer is relaxing (watching TV, etc.).

WARNING:

Weight Limit - 150 kg

Height Limit - 2 m

Use of COMBO with any product other than ToeOFF® or BlueROCKER® is prohibited.



1. Joints: One size
2. Tibia Connector: Generally, select the same size as the ToeOFF/ BlueRocker. However, the next smaller size will “snug” the wings of the ToeOFF/BlueRocker closer to the leg for the extra small calf, and the next larger size may better accommodate a larger calf.
3. Knee Control Component with Popliteal Interface: Take a M-L measurement at the knee (knee width).
4. Thigh Cuff: Take a circumferential measurement at height where thigh cuff is to be located, however, make certain it is not less than 10 cm above the tibial plateau. Take a M-L measurement at same height.
5. Thigh Cuff SOFTKIT™: Same size as thigh cuff.

COMBO can not be assembled to ToeOFF Flow 2 1/2; ToeOFF Short or BlueROCKER Short.

5 Components + ToeOFF® or BlueROCKER® Required to build a Combo

Measurement guidelines on previous page.

1 Joints with uprights

Item No.	Size
28780 0000	One Size

2 Tibia Connector

Item No.	Size
28784 0011	Small
28784 0012	Medium
28784 0013	Large

3 Knee Control Component with Popliteal Interface

Item No.	Size	Medial - Lateral
28782 0011	Small	7 - 10,5 cm
28782 0012	Medium	9,5 - 13 cm
28782 0013	Large	12,5 - 16 cm

4 Thigh Cuff

Item No. Left	Item No. Right	Size	Circumference	Medial - Lateral
28781 1011	28781 2011	Small	30 - 40 cm	11 - 15 cm
28781 1012	28781 2012	Medium	38 - 50 cm	13 - 17 cm
28781 1013	28781 2013	Large	48 - 60 cm	15 - 19 cm
28781 1014	28781 2014	XLarge	58 - 70 cm	17 - 21 cm

5 Thigh Cuff SoftKIT

Item No.	Size (set of 2)
28783 0011	Small
28783 0012	Medium
28783 0013	Large
28783 0014	XLarge

Replacement Combo Calf Strap

Item No.	Size
28796 0000	One Size

Important

Please complete the order form for COMBO which can be downloaded from our web site. Components of the COMBO require customisation to individual patient. Workshop tools are required for assembly. For first time compilation, please allow approximately 1 ½ hours to customise the components. Allard UK also offers an assembly service. Please contact us about this service. View the assembly video on our web site.



CROSS™ Knee Hyperextension orthosis

Cross™ is a functional combination orthosis with unique one-handed application. It is intended for mild to moderate knee hyperextension due to neuromuscular diseases or other injuries. The brace can be used together with an Allard AFO when knee hyperextension is present together with foot drop.

- Anatomically shaped patella opening with silicone buttress
- Silicone band strategically placed to prevent migration
- Self-contouring Condyle shells
- Adjustable ROM stops:
Flexion: 45°, 60°, 75°, 90°
Extension: 10°, 20°, 30°, 40°
- Hyperextension resistance is easily adjusted with one hand
- Shaped reinforcement stays to provide guidance for patient to correctly align the support.
- Pre-flexed anatomical shape fits the contours of the leg to provide comfortable fit under AFO.



Patient friendly features include thin, breathable lightweight material with an ultra-smooth friction liner with no visible seams.

Supplied with unique Cross™ donning aid which allows for one-hand application, well suited for patients with limited balance to don the orthosis themselves while in a seated position and those patients with hemiplegia or limited hand dexterity.

Item No.	Description	Size	15cm below Mid Patella	Mid Patella	15cm above Mid Patella
28715 0011	Knee orthosis	Small	32-37cm	32-37cm	39-44cm
28715 0012	Knee orthosis	Medium	36-41cm	36-41cm	43-48cm
28715 0013	Knee orthosis	Large	40-45cm	40-45cm	47-52cm
28715 0014	Knee orthosis	X-Large	44-49cm	44-49cm	51-57cm
28716 0000	CROSS™ Donning aid	One Size	-	-	-



SELECTION® Knee Patella

This brace is especially designed for treatment of different kinds of patella related conditions. The patella pad can be moved into different positions - medially, laterally or underneath the patella. The brace gives light stabilization and has stainless steel spiral stays on the sides.

Item No.	Size	15 cm below patella	Mid patella	15 cm above patella
35704 0010	XSmall	28 - 31 cm	30 - 33 cm	34 - 39 cm
35704 0011	Small	31 - 34 cm	33 - 36 cm	39 - 43 cm
35704 0012	Medium	34 - 37 cm	36 - 39 cm	43 - 47 cm
35704 0013	Large	37 - 40 cm	39 - 42 cm	47 - 51 cm
35704 0014	XLarge	40 - 43 cm	42 - 46 cm	51 - 56 cm



SELECTION® Knee Minor

Knee Minor is a tube version with stainless steel spiral stays on each side. It gives mild support and good compression. Minor is adjustable on the front of the thigh and on the calf. It also has an anatomically shaped patella opening and silicon "Stay-Up" on the inside to prevent migration.

Item No.	Size	15 cm below patella	Mid patella	15 cm above patella
35700 0010	XSmall	28 - 31 cm	30 - 33 cm	34 - 39 cm
35700 0011	Small	31 - 34 cm	33 - 36 cm	39 - 43 cm
35700 0012	Medium	34 - 37 cm	36 - 39 cm	43 - 47 cm
35700 0013	Large	37 - 40 cm	39 - 42 cm	47 - 51 cm
35700 0014	XLarge	40 - 43 cm	42 - 46 cm	51 - 56 cm
35700 0015	XXLarge	43 - 47 cm	46 - 50 cm	56 - 60 cm



SELECTION® Knee Minor Wrap

Knee Minor Wrap is a "wrap-around-model" with stainless steel spiral stays on each side. It gives mild support and good compression. It has an anatomically shaped patella opening and silicon "Stay-Up" on the inside to prevent migration. Minor Wrap also comes in PLUS sizes to accommodate larger thigh circumferences.

Item No.	Size	15 cm below patella	Mid patella	15 cm above patella
35701 0010	XSmall	25 - 28 cm	27-30 cm	31 - 36 cm
35701 0011	Small	28 - 31 cm	30 - 33 cm	36 - 40 cm
35701 0115	Small +	28 - 31 cm	30 - 33 cm	40 - 44 cm
35701 0012	Medium	31 - 34 cm	33 - 36 cm	40 - 44 cm
35701 0125	Medium +	31 - 34 cm	33 - 36 cm	44 - 48 cm
35701 0013	Large	34 - 37 cm	36 - 39 cm	44 - 48 cm
35701 0135	Large +	34 - 37 cm	36 - 39 cm	48 - 53 cm
35701 0014	XLarge	37 - 40 cm	39 - 43 cm	48 - 53 cm
35701 0145	XLarge +	37 - 40 cm	39 - 43 cm	53 - 60 cm
35701 0015	XXLarge	40 - 46 cm	43 - 50 cm	53 - 60 cm
35701 0155	XXLarge +	40 - 46 cm	43 - 50 cm	60 - 67 cm





SELECTION® Knee Optima

This model is a "pull-on" version. It combines a range of motion control with medial/lateral stability and compressive support for knee instability. It also give assistance in reducing hyperextension, adding M-L stability and can assist in A-P instability. It has an anatomically shaped patella opening and silicon "Stay-Up" on the inside to prevent migration.

Item No.	Size	15 cm below patella	Mid patella	15 cm above patella
35702 0010	XSmall	28 - 31 cm	30 - 33 cm	34 - 39 cm
35702 0011	Small	31 - 34 cm	33 - 36 cm	39 - 43 cm
35702 0012	Medium	34 - 37 cm	36 - 39 cm	43 - 47 cm
35702 0013	Large	37 - 40 cm	39 - 42 cm	47 - 51 cm
35702 0014	XLarge	40 - 43 cm	42 - 46 cm	51 - 56 cm
35702 0015	XXLarge	43 - 47 cm	46 - 50 cm	56 - 60 cm



SELECTION® Knee Optima Wrap

This model is a "wrap-around-model". It combines a range of motion control with medial/lateral stability and compressive support for knee instability. It also give assistance in reducing hyperextension, adding M-L stability and can assist in A-P instability. It has an anatomically shaped patella opening and silicon "Stay-Up" on the inside to prevent migration. Optima Wrap also comes in PLUS sizes to accommodate larger thigh circumferences.

Item No.	Size	15 cm below patella	Mid patella	15 cm above patella
35703 0010	XSmall	25 - 28 cm	27-30 cm	31 - 36 cm
35703 0011	Small	28 - 31 cm	30 - 33 cm	36 - 40 cm
35703 0115	Small +	28 - 31 cm	30 - 33 cm	40 - 44 cm
35703 0012	Medium	31 - 34 cm	33 - 36 cm	40 - 44 cm
35703 0125	Medium +	31 - 34 cm	33 - 36 cm	44 - 48 cm
35703 0013	Large	34 - 37 cm	36 - 39 cm	44 - 48 cm
35703 0135	Large +	34 - 37 cm	36 - 39 cm	48 - 53 cm
35703 0014	XLarge	37 - 40 cm	39 - 43 cm	48 - 53 cm
35703 0145	XLarge +	37 - 40 cm	39 - 43 cm	53 - 60 cm
35703 0015	XXLarge	40 - 46 cm	43 - 50 cm	53 - 60 cm
35703 0155	XXLarge +	40 - 46 cm	43 - 50 cm	60 - 67 cm



ELEMENT Stretch-UP Sock

This simple sock is designed to keep tension on the tissue (plantar fascia) to help it heal in a stretched position at night or at rest. Because of this many users find less morning pain in the heel area.

Item No.	Size	Calf circumference
34108 0011	Small	< 20 cm
34108 0012	Medium	20 - 40 cm
34108 0013	Large	> 40 cm

C.H.E.C.K.™

Comfortable Hyper-Extension Control Knee

Stainless Steel with Condyle Pad

Weight: 640 grams. Offers increased M-L and AP stability and includes condylar pads for closer fit.

Comfortable Hyperextension Control

Longer uprights (when compared to the Swedish Knee Cage) reduce the amount of pressure required on the femur and tibia to control hyperextension, making the orthosis better tolerated by the patient.

Effortless Motion Joint

Dual axis joints allow for full knee flexion and allow each of the four uprights to move independently over each other, from extension to flexion, enabling the orthosis to follow the natural movement of the leg and prevent downward migration.

Low profile

Low profile hinges with slim uprights that are easily shaped to fit the contours of the leg to create an orthosis that becomes virtually unnoticeable under clothing.

Comfortable Frame Suspension System & Tissue Interface

Made of synthetic leather laminated with polyurethane foam and brushed polyester tricot. These unique pads provide a soft interface between soft tissue and the orthosis.

Easy to Don and Doff

D-loops are available for patients with limited use of their hands to make the application of the device easier. Straps are attached to the suspension sleeves eliminating confusion of which strap goes where. After initial fitting, wearer just closes or opens one side only of the front straps for simple application and removal.

One Size

Posterior upright connection bar adjusts to fit knee widths from 9 to 13 cm.

Indications

Genu recurvatum, Unstable knee caused by laxity of the ligaments, Mild valgus instability, Mild varus instability, Neurologic function impairment (post C.V.A.).

Contraindications

Not suitable for sports activities

Item No.	Description	Size	Knee Width	Total length
28652 0000	C.H.E.C.K. Stainless Steel	One Size	9 - 13 cm	45 cm
28651 0000	Replacement Interface	One Size		
28653 0000	D-Ring set of 4	One Size		

Important: Loctite®, not supplied with the product, must be applied to all screws at the time of fitting.

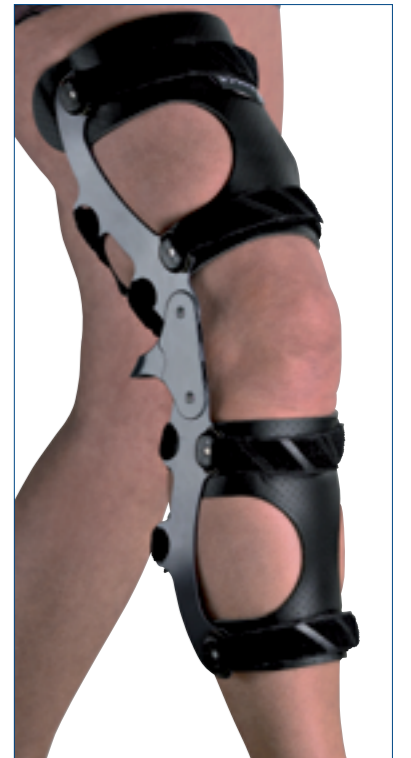

Our range of Osteoarthritis Orthoses

In collaboration with VQ Orthocare we offer a range of unique knee orthoses for the relief of symptoms caused by Osteoarthritis (OA). Our wide range of varied high quality OA knee braces provide individualized patient centered solutions with different levels of support and control.



OActive®2

Catalyst-Propel™ OA

TRUalign OA™

The choice of knee orthosis for the management of osteoarthritis is primarily based on the degree of deterioration and the patient's activity level. Factors to consider when prescribing a brace for your patient should include your orthotic goal, the patient's experience and any additional soft tissue damage.

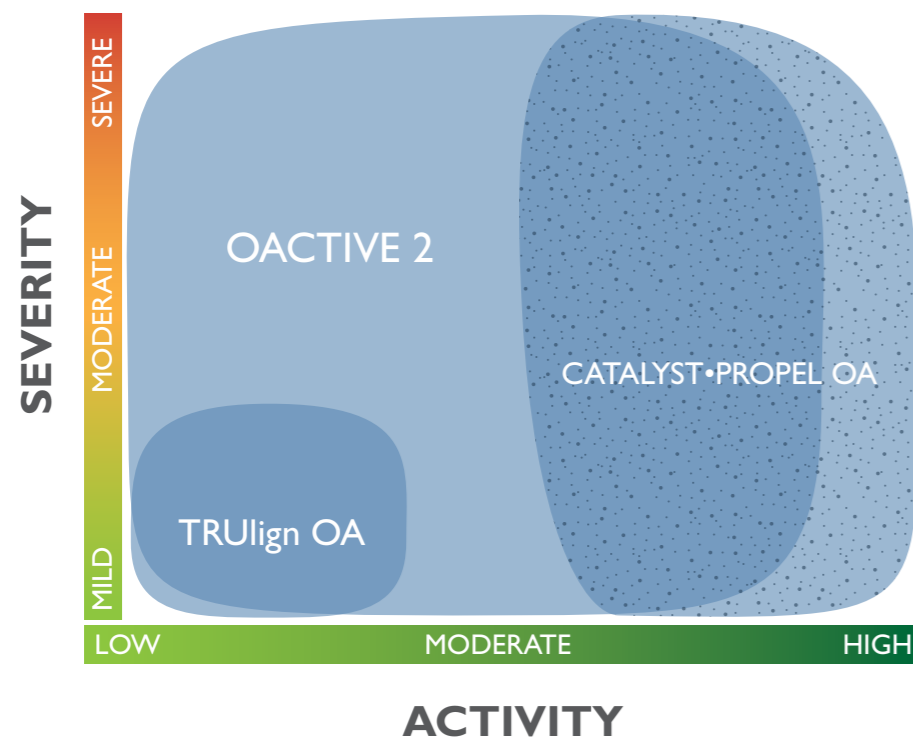

OActive®2 is suitable for most patients regardless of activity level or degree of injury.

Q-hinge technology

The Q-hinge changes the overall valgus/varus angle of the orthosis for optimal correction. This provides the opportunity to fine-tune the correction forces during the fitting process based on the patient's pathology and tolerance for a clinical effect that meets the requirements.



OACTIVE®2 FOR MEDIAL OA

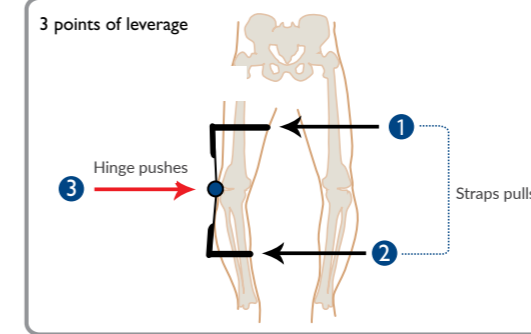

OACTIVE®2 FOR LATERAL OA

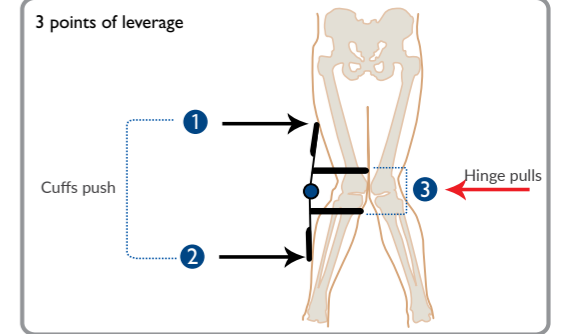

CATALYST PROPEL FOR MEDIAL OA

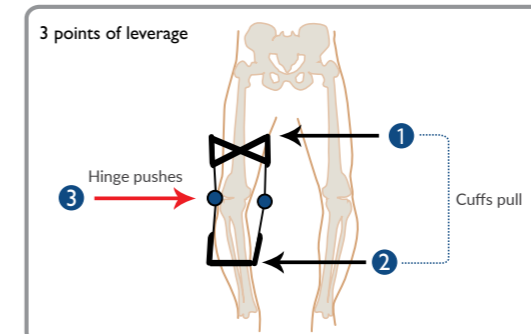

CATALYST PROPEL FOR LATERAL OA

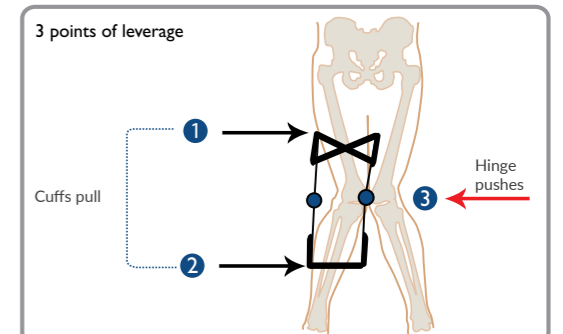

TRULIGN™ OA FOR MEDIAL OA

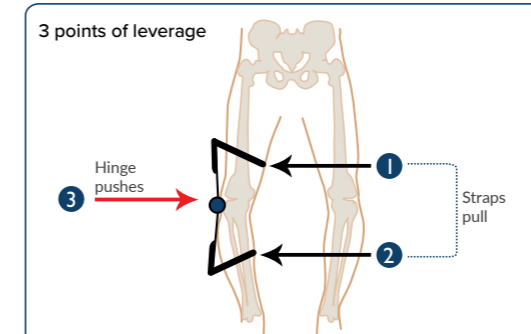

TRULIGN™ OA FOR LATERAL OA

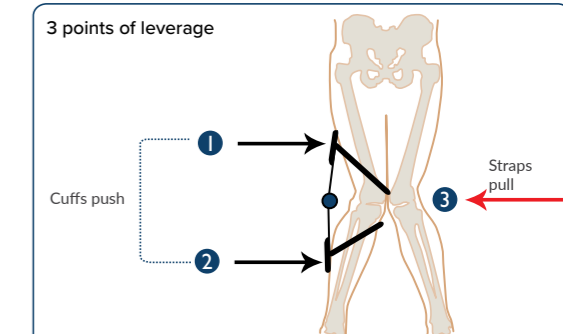



Push button



Set-Fit Buckle

OACTIVE®2

The OActive® 2 knee orthosis for the treatment of knee Osteoarthritis is made from aluminium, is lightweight and flexible. It is available in one size. The simple low-profile design makes it less visible under clothing. The brace has smart innovative buckles to facilitate donning and doffing.

Available with two hinge options:

- Standard hinge for patients weighing under 136Kgs
- Heavy Duty hinge for patients weighing over 136Kgs

The unique Q-joint adjusts both clockwise and counterclockwise to achieve the desired relief which can also be set to limit the range of motion for extension and flexion independently. The orthosis can also be sent for free motion. Supplied with 5° stop installed. There are various extension and flexion stops provided with each orthosis.

OActive® 2 is available in the following options:

- Suspension Wrap with either Push Button or Set Fit Buckles
- Tibia Cuff with either Push Button or Set Fit Buckles

OActive® 2 with Suspension Wrap can be used in two ways. Either by placing the Suspension Wrap over the lower part of the orthosis or alternatively by placing it between the legs and the orthosis. Both options prevent the brace from migrating on the leg.

OActive® 2 with heat mouldable Tibia Cuff with Exothermic Heat Pack for easy custom fitting and prevention of distal migration for a better fit.

Indications

Mild to severe uncompartimentalised Osteoarthritis.

Item No. Left	Item No. Right	Description	Hinge	Size
550001000	550002000	OActive 2 Push Button with Suspension Wrap	Standard	One Size
550151000	550152000	OActive 2 Set-Fit Buckle with Suspension Wrap	Standard	One Size
550161000	550162000	OActive 2 Set-Fit Buckle with Suspension Wrap	Heavy Duty	One Size
550171000	550172000	OActive 2 Push Button with Suspension Wrap	Heavy Duty	One Size
550291000	550292000	OActive 2 Push Button with Tibia Cuff	Standard	One Size
550301000	550302000	OActive 2 Set-Fit Buckle with Tibia Cuff	Standard	One Size



Suspension Sleeve Under brace



Suspension Sleeve Over brace



TRULIGN OA

The TRUalign OA™ is a unilateral knee orthosis for the management of mild to moderate unilateral knee osteoarthritis. The orthosis has a single-sided joint designed into a user friendly 'wrap around' orthosis with Push Buttons to facilitate easy donning and doffing.

Anatomically designed with high stretch, airy material for a compression and a comfortable fit. The Q-joint technology provides the patient with symptom relief from the 3-point pressure principle known to reduce pressure and pain in knee Osteoarthritis.

Features and Benefits

Increased patient compliance as it is:

- Easy to apply.
- Breathable, comfortable and conforms to the anatomy.
- Q-hinge angular adjustment delivers optimized 3-point leverage for maximum relief.

Indications:

Unilateral medial or lateral, mild to moderate knee Osteoarthritis.

Item No. Left	Item No. Right	Description	Size	Circumference 15cm above Patella	Circumference 15cm below Patella
550181011	550182011	Trulign OA	Small/Medium	36-47cm	28-36cm
550181012	550182012	Trulign OA	Medium /Large	47-65cm	36-48cm
550181013	550182013	Trulign OA	Large / X-Large	65-81cm	48-64cm



Catalyst Propel OA

The Catalyst Propel OA™, a four-point knee orthosis features a unique Active Thigh Cuff™ (ATC) solution on the front of the thigh which is flexible and strong for the ultimate suspension. The orthosis provides protection and comfort by moving with the muscles. With a strong but low-profile aluminium frame of the highest quality.

The Q-joint of the orthosis is adjusted clockwise or counterclockwise to achieve the desired relief. Start with the brace in the neutral position, with knee bent at 90° and turn 1/8th of a turn at a time to adjust the relief. Various flexion and extension stop provided with each brace. The orthosis can also be set up to limit the range of motion for extension and flexion independently as well as set for free motion.

Indications:

Management of mild to severe unilateral knee Osteoarthritis in combination with knee instability or after injury to reduce the load on the joint.

Item No. Left	Item No. Right	Description	Size	Circ. 15cm above Patella	Circ. Mid Patella	Circ.15cm below Patella
550011011	550012011	Catalyst Propel OA	Small	37-43cm	29-33cm	29-33cm
550011012	550012012	Catalyst Propel OA	Medium	43-50cm	33-38cm	33-37cm
550011013	550012013	Catalyst Propel OA	Large	50-57cm	38-43cm	37-42cm
550011014	550012014	Catalyst Propel OA	X-Large	57-65cm	43-48cm	42-47cm
550011015	550012015	Catalyst Propel OA	XX-large	65-76cm	48-56cm	47-56cm





Boston Brace

Introduction

Allard Support UK Ltd manufactures and supplies the full range of Original Boston Brace products, as we have done since 1995.

The Boston Bracing system was conceived in Boston's Children's Hospital in 1972 and subsequently developed as a cooperative venture between Bill Miller CPO and Dr John Hall. This same Boston Brace system is widely used throughout the world and is still regarded as the preferred treatment protocol for the conservative treatment of Idiopathic Scoliosis. Over the years, other braces have emerged which exhibit similar shapes and purposes and the term "Boston Brace" has often been applied to them. However, none of these braces have managed to repeat the success of the Original Boston Brace and none can be compared in terms of the volume of medical based evidence available to support its effectiveness.



Our product Range has grown over the years and includes:

- Boston Scoliosis Brace
- Boston Overlap Brace
- Boston Soft Body Jacket
- Boston Lite
- Custom Spinal Orthosis to Measurement, Cast or Scan
- Boston Body Jacket
- Boston Soft AFO
- Boston Hip Abduction Brace
- Various Accessories.

Our Services

In addition to the supply of our standard Boston product range, our central fabrication capability (15,000 ft²) allows us to offer a wide range of services and benefits to your clinic or workshop and most importantly, your patient, with regard to the manufacture and supply of a wide range of Custom Made Spinal Orthotic products, finished to your specifications and ready for fitting to the patient.



Custom/Bespoke Orthosis

We will manufacture the spinal orthosis you require to either measurement, cast or modified scan. The formats we can accept are .stl, .cpxp and Vorum Spectra Scan.

The orthosis are available in a variety of material types, thicknesses and colour transfer patterns. Technical advise on possible options that may enhance the integrity and performance of your orthosis, taking into account your specific patient needs/pathology.

The orthosis can be fully finished (to first fitting stage), trimmed to size, buffed, with fastenings attached, etc. Our extensive library of body molds allows us the ability to manufacture these products more efficiently and faster than anyone in the industry, thus providing a very cost effective option for our customers.

Central Fabrication- Benefits to You

- Access to 30 years experience in spinal orthotic design and manufacture.
- Fully finished Orthosis.
- Cost Effective Central Fabrication.
- Fast & Efficient delivery service.
- Quality products and materials, manufactured in an ISO9001:2015 certified environment.
- Products shipped directly to your clinic/hospital.



The Original Boston Scoliosis Brace

The original Boston Brace system for the non-operative treatment of idiopathic scoliosis, utilises a prefabricated, standardised symmetrical module chosen on the basis of the patients physical dimensions. The brace is manufactured from polypropylene and lined with foam. The Boston Brace system is still the preferred choice in the non-operative treatment of scoliosis.

Indications

Idiopathic Scoliosis

Benefits

- Proven System, 30 stock sizes
- Available in 15° and 0° lordosis
- Custom made to measurements, cast or scan.

Brace / Curve Types

- Lumbar curves – Apex L1 and below
- Thoracic /Double Curves – Apex up to T6
- Thoraco – Lumbar curves – Apex T12 –L1
- Low Thoracic Curves – Apex T10 – T11

Standard Material

- Orthopaedic grade copolymer
- Hypo-allergenic Polyethylene foam liner

Made-to-Measure form on page 86.
Standard size chart on page 88.



Boston Night Brace

Our many years of experience and knowledge have taught us that not all patients will be suitable for the original Boston Brace. For patients with smaller magnitude curves and perhaps a dramatic physical or psychological reaction to wearing a full time brace, there is a need to have an alternative orthosis to offer. For this reason, we have developed the Boston Scoliosis Night Brace to give the orthotist and clinician an alternative orthosis for use with a certain patient group who exhibit some of the characteristics mentioned above.

Principles

The Boston Scoliosis Night Brace is designed to be worn only at night, during sleep. It is molded to conform to the patient's body while he/she is bent towards the convexity of the curve, thus 'over-correcting' the curve during the eight hours it is worn. The objective of the Boston Scoliosis Night Brace is to biomechanically correct the scoliosis via stabilizing, lateral shift and unbending forces.

Indications

Idiopathic Scoliosis

Benefits/Features

The Boston Scoliosis Night Brace utilises several key design features which we feel will ultimately result in increased patient comfort and adjustability:

- **Extra Comfort**
Additional layers of inner foam liner which provide increased patient comfort during the wearing periods.
- **Removable Internal Liner**
Can be easily removed from the outer plastic shell in order to allow for ease of cleaning and adjustment.
- **Reduced Edge Pressure**
The internal foam liner overhangs the external plastic shell to eliminate edge pressure (from the edge of the plastic shell) which is evident on most other braces.

Standard Material

- Orthopaedic grade co-polymer
- Hypo-allergenic Polyethylene foam liner

Made-to-Measure form on page 86. S
tandard size chart on page 88.





The Boston Overlap Brace

The original Boston Overlap Brace (BOB) is an anterior opening LSO thermoplastic brace specifically designed for patients suffering from chronic or temporary low back pain. The prefabricated modules are available in 15° and 0° of Lordosis. The BOB can be supplied unlined or lined with a 3.5mm thermofoam lining. In addition to 20 standard stock sizes, the BOB can be manufactured to cast or measurement.

Indications

Mechanical back pain, Discogenic low back pain, Compression fractures, Spondylolysis, Spondylolisthesis, Osteoporosis, Spinal arthrosis, Spinal stenosis, Pre and Post-operative care

Benefits / Features

- 20 Stock Sizes
- Custom to Cast or Measurement
- Lightweight
- Sturdy yet comfortable
- For treatment of sports injuries
- Easily trimmed to size

Options

Available as Soft BOB and with removable or permanent Stays.

Standard Material

- 3 mm Low Density Polyethylene,
- 3 mm Polyethylene foam,
- Front steel closure

Made-to-Measure form on page 86.
Standard size chart on page 88.



Boston Soft Body Jacket

The original Boston Soft Body Jacket (BSBJ) is a spinal orthosis designed to make control more comfortable for patients who cannot tolerate rigid compression. The BSBJ remains flexible while providing support with strategically placed stays (reinforcements). Alternatively, the product can be manufactured with either Internal or External polypropylene frame, where slightly more rigidity is required.

Indications

Neuromuscular Scoliosis, Seating and Positioning (Posture Control), Myelomeningocele, Cerebral Palsy, Muscular Dystrophy

Benefits / Features

- 30 Stock Sizes,
- Custom to Measurement or Cast
- Separate vertical stays allow increased diaphragm expansion for improved respiration
- Reduced skin pressure and related problems
- Improved positioning and seating stability
- Especially beneficial for children and non surgical candidates
- Light and flexible
- Easy to trim
- Supplied with fastening straps

Options

Removable Stays, Permanent Stays, Internal Frame, External Frame, Anterior/Posterior/Bi-valve opening, Colour options.

Standard Material

- 3 mm Firm Polyethylene foam outside
- Co-polymer stays
- Copolymer frame
- 4.5 mm Soft Polyethylene foam inside





Boston LITE™

Based on the concept of the Boston Soft Body Jacket the Boston Lite™ is thinner and more ventilated but with the same proven stability.

By merging the two materials and using certain shapes it is easier to accommodate the brace to the user's needs for ventilation and feeding tubes.

The lining is a separate piece made from a 3D-spacer material. This material provides comfort by absorbing moisture and increases ventilation to keep the skin more cooler and drier. The spacer also works as a pressure divider towards the body. The liner is used instead of a traditional T-shirt.

Low profile buckles have been developed that contributes to a more low profile design. *Boston LITE is only available with a posterior opening at this time.*

Indications

Neuromuscular scoliosis. Trunk control and postoperative support.

Made-to-Measure form on page 86.
Standard size chart on page 88.

Item No.	Model	Size	Hip	Waist	Xyphoid	Lordosis degree
BBL-15J1	Stock Size Module	J1	54	40	49	15°
SBBL-15J2	Stock Size Module	J2	58	42	51	15°
SBBL-15J3	Stock Size Module	J3	62	45	54	15°
SBBL-15J4	Stock Size Module	J4	64	47	56	15°
SBBL-15Y1	Stock Size Module	Y1	67	46	56	15°
SBBL-15Y1A	Stock Size Module	Y1A	66	51	55	15°
SBBL-15Y2	Stock Size Module	Y2	71	47	60	15°
SBBL-15Y2A	Stock Size Module	Y2A	72	55	62	15°
SBBL-15Y3	Stock Size Module	Y3	75	48	63	15°
SBBL-15Y3A	Stock Size Module	Y3A	78	57	69	15°
SBBL-15Y4	Stock Size Module	Y4	79	51	64	15°
SBBL-15Y4F	Stock Size Module	Y4F	80	57	66	15°
SBBL-L1	Liner	1 (15J1-15J2)	-	-	-	-
SBBL-L2	Liner	2 (15J3-15J4)	-	-	-	-
SBBL-L3	Liner	3 (15Y1-15Y2)	-	-	-	-
SBBL-L4	Liner	4 (15Y1A-15Y2A)	-	-	-	-
SBBL-L5	Liner	5 (15Y3-15Y4)	-	-	-	-
SBBL-L6	Liner	6 (15Y3A-15Y4F)	-	-	-	-
SBBL-S	Single Strap & Buckle	One Size	-	-	-	-
SBBL-S/SET	Set of 3 Straps & Buckles	One Size	-	-	-	-
SBBL-B	Buckle Cover	One Size	-	-	-	-

Boston Body Jacket

The Boston Body Jacket is designed to immobilise spinal patients from neck to hips. This custom TLSO promotes rapid fusion for shorter hospital stays and is therefore the ideal post-operative brace for your patients. Choose from different materials and openings.

Indications

Post-operative, Compression Fractures, Spinal Immobilization.

Benefits / Features

- 12 Bi-valve Stock sizes
- Custom by cast or measurements
- Anterior / Posterior / Lateral / Bi-Valve Openings
- TLSO / LSO (Lumbar Sacral Orthosis)
- Low Density Polyethylene or Polypropylene
- Can be finished to first fitting stage.

Standard Material

- Low Density Polyethylene
- Hypo-allergenic
- Polyethylene foam liner

Women's Stock Sizes

Item No.	Size	Hip	Waist	Xyphoid
BJF01	X-Small	88-99 cm	69-79 cm	76-86 cm
BJF02	Small	94-104 cm	74-84 cm	81-91 cm
BJF03	Medium	99-109 cm	79-89 cm	86-94 cm
BJF04	Large	104-114 cm	89-99 cm	96-107 cm
BJF05	X-Large	109-119 cm	91-102 cm	99-109 cm
BJF06	XX-Large	119-130 cm	112-122 cm	112 - 125 cm

Men's Stock Sizes

Item No.	Size	Hip	Waist	Xyphoid
BJM01	X-Small	89-99 cm	76-86 cm	84-94 cm
BJM02	Small	94-104 cm	81-91 cm	90-99 cm
BJM03	Medium	99-109 cm	86-96 cm	94-104 cm
BJM04	Large	104-114 cm	96-107 cm	104-114 cm
BJM05	X-Large	109-119 cm	99-109 cm	106-117 cm
BJM06	XX-Large	119-130 cm	119-130 cm	119-130 cm





Boston Soft AFO

The Boston Soft AFO is manufactured from polyethylene foam with a 3mm polypropylene heel insert which is laminated between a high density outer foam layer and a lower density inner foam skin.

Indications

Myelomeningocele, Muscular Dystrophy, Cerebral Palsy, Trauma, Heel Ulcerations

Standard Material

- Orthopaedic grade co-polymer (Internal Reinforcement)
- Hypo-allergenic Polyethylene foam liner

Benefits / Features

- Enhances Positioning
- Reduces Spastic Tone
- Wipes clean with soap and water
- Ambulation possible with cast boot
- Easily trimmed with scissors,
- Inexpensive alternative to custom AFO
- Can be used on either the left or right foot
- Optional anti-rotational stabilizer bar
- Built-In heel relief promotes the healing of ulcers
- Made with non-alergenic foam to ensure patient comfort
- Light weight
- Fully adjustable

Item No.	Description	Size	UK Shoe Size	European Shoe Size
AFO-P1	Paediatric	1	2-3	19-20
AFO-P1S	Paediatric w Stabilizer	1	2-3	19-20
AFO-P2	Paediatric	2	4-5	21-22
AFO-P2S	Paediatric w Stabilizer	2	4-5	21-22
AFO-P3	Paediatric	3	6-7	23-24
AFO-P3S	Paediatric w Stabilizer	3	6-7	23-24
AFO-P4	Paediatric	4	8-9	25-26
AFO-P4S	Paediatric w Stabilizer	4	8-9	25-26
AFO-P5	Paediatric	5	10-11	27-29
AFO-P5S	Paediatric w Stabilizer	5	10-11	27-29
AFO-P6	Paediatric	6	12-13	30-31
AFO-P6S	Paediatric w Stabilizer	6	12-13	30-31
AFO-A	Adult	A	1-2	32-34
AFO-AS	Adult w Stabilizer	A	1-2	32-34
AFO-B	Adult	B	3-4	35-36
AFO-BS	Adult w Stabilizer	B	3-4	35-36
AFO-C	Adult	C	5-6	37-39
AFO-CS	Adult w Stabilizer	C	5-6	37-39
AFO-D	Adult	D	7-8	40-41
AFO-DS	Adult w Stabilizer	D	7-8	40-41
AFO-E	Adult	E	9-10	42-44
AFO-ES	Adult w Stabilizer	E	9-10	42-44
AFO-F	Adult	F	11-12	45-46
AFO-FS	Adult w Stabilizer	F	11-12	45-46

Please quote item number when ordering Boston Soft Afos

Boston Hip Abduction Brace

The Boston Hip Abduction Brace is a lightweight paediatric orthosis with a frame that is manufactured from sturdy Polypropylene and a closed cell foam liner which does not retain moisture. This orthosis maintains concentric reduction of hips in patients with displasia. The product can replace spica casts and harnesses for certain developmental dysplasia patients.

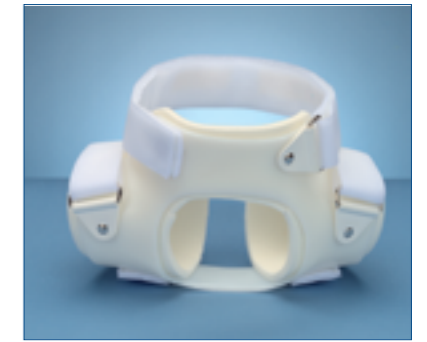

Indications

Congenital Hip dislocation, Hip Displasia, Cerebral Palsy

Benefits / Features

- Easy to apply
- Lightweight
- Convenient for nappy change
- Closed cell foam liner does not absorb moisture
- Easily cleaned

Standard Material

- High Density Polyethylene
- Hypo-allergenic Polyethylene foam liner

Item No.	Size	Pelvic circumference
HPXXS	XX-Small	26-30 cm
HPXS	X-Small	30-38 cm
HPS	Small	38-46 cm
HPM	Medium	46-51 cm
HPL	Large	51-56 cm

Please quote item number when ordering Boston Hip Abduction Brace.

Universal Spinal Measurement Form

P.O.# _____
 Date: _____
 Delivery date: _____
 Ship To: _____

Customer: _____
 Patient ID: _____
 Age: _____ Height: _____ Sex: _____
 Diagnosis: _____

Has the patient used a Boston Brace before: Yes No
 Date of last order/order no.: _____

Brace Design:
 Degree of Lordosis: _____
 Brace to be made to Measurements Cast Scan
 Opening: Anterior Posterior
 Bivalve Left Lateral
 Right Lateral
 Overlap: YES NO
 Finished to first fitting YES NO

Brace Type:
 Scoliosis Flexaform
 BOB (Unlined) BOB (Lined)
 Soft Body Jacket (Removable stays)
 Soft Body Jacket (Permanent stays)
 Soft Body Jacket with Internal Frame
 Soft Body Jacket with External Frame
 Body Jacket (Lined) Body Jacket (Unlined)
 Boston LITE

Should patient's belly size be taken into consideration when producing the brace?
 NO Yes (if yes, please enclose a photo where possible)
 Are Breasts Built into Brace? Yes No
 Bra Cup Size _____ Height from waist to Nipple Line _____

Material & Thickness (if non-standard required):
Color:
 Soft Body Jacket and Boston LITE: White Orange Blue Pink Purple
 Other braces, including SBJ External frame:
 All over transfer pattern: _____
 Single placement transfer: _____

Remarks _____

By submitting this form you are certifying that personal data has been processed in compliance with GDPR (EU) 2016/679. The data will be processed only to the extent necessary to deliver ordered products. Due to the Data Privacy Regulation GDPR (EU) 2016/679 this form must be submitted through <https://submit.allardsupport.com>.

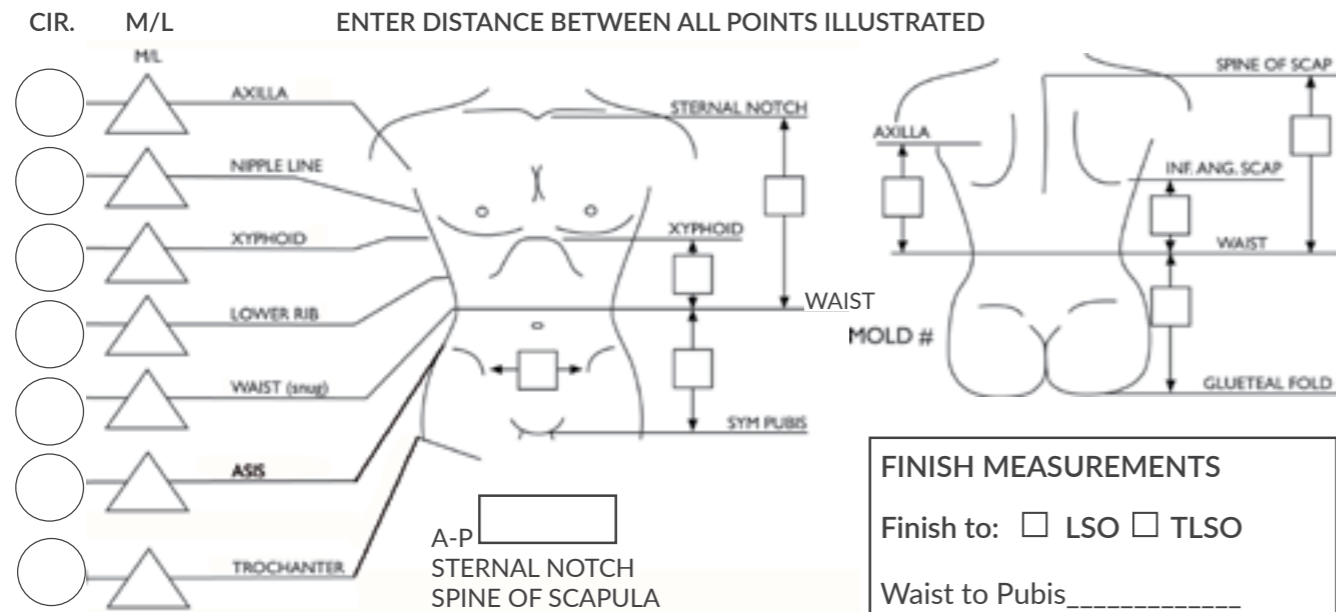

FINISH MEASUREMENTS
 Finish to: LSO TLSO
 Waist to Pubis _____
 Waist to Xyphoid _____
 Waist to Axilla _____
 Waist to Sternal Notch _____
 Waist to Inferior Angle _____
 Waist to Spine of Scapula _____
 Waist to Seat _____

Signed _____

Boston Scoliosis Night Brace Measurement Chart

P.O.# _____
 Date: _____
 Delivery date: _____
 Ship To: _____

Customer: _____
 Patient ID: _____ Age: _____ Height: _____ Sex: _____
 Diagnosis: _____

Orthosis Design
 Provide major curve: Left Right
 Brace bending to: Left Right
 Cobb Angles: _____ Lumbar _____ Thoracic

Brace Options: Opening is always anterior
 Removable liner Permanent liner
 Finished: Yes NO
 Options: Transfer/Pattern _____

Curve Description
 Thoracic curve: Left Right
 Lumbar curve: Left Right
 Thoracic apex: Th- _____ Lumbar apex: L- _____

Curve Type
 Thoracic Lumbar
 Thoracolumbar Double

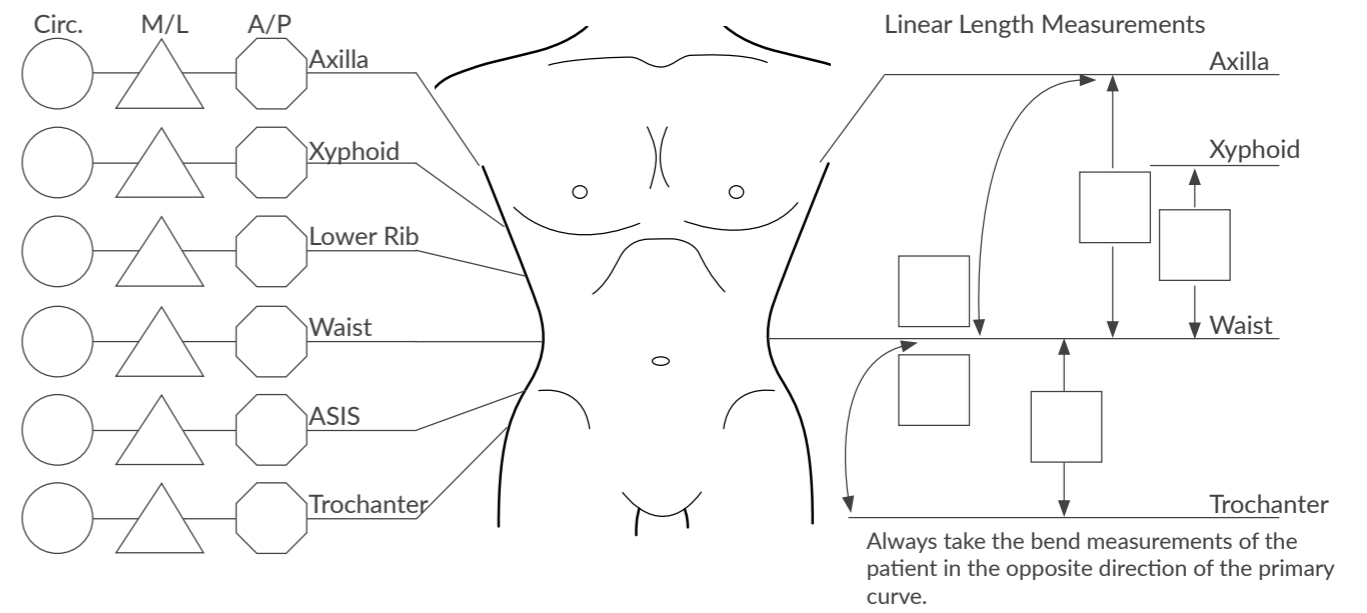

Special instructions or remarks: _____

Size chart B.O.B

Size	Hip cm	Waist cm	Chest cm
1	71	51	66
1D	71	45	58,5
2	76	61	71
2D	76	51	63,5
3	81	71	76
3D	81	66	74
4	86,5	76	84
4D	86,5	58,5	69
5	91,5	81	89
5D	91,5	66	76
6	96,5	86,5	94
6D	96,5	74	84
7	101,5	91,5	99
7D	101,5	81	91,5
8	109	96,5	109
8D	109	84	91,5
9	114	100	114
9D	114	87	94
10	117	104	117
10D	117	96	101

Size Chart Boston LITE

Item No.	Size	Hip cm	Waist cm	Chest cm
SBBL-15J1	15J1	54	40	49
SBBL-15J2	15J2	58	42	51
SBBL-15J3	15J3	62	45	54
SBBL-15J4	15J4	64	47	56
SBBL-15Y1	15Y1	67	46	56
SBBL-15Y1A	15Y1A	66	51	55
SBBL-15Y2	15Y2	71	47	60
SBBL-15Y2A	15Y2A	72	55	62
SBBL-15Y3	15Y3	75	48	63
SBBL-15Y3A	15Y3A	78	57	69
SBBL-15Y4	15Y4	79	51	64
SBBL-15Y4F	15Y4F	80	57	66

Size chart Scoliosis and Soft Body Jacket

Size	Hip cm	Waist cm	Chest cm
J1	54	40	49
J2	58	42	51
J3	62	45	54
J4	64	47	56
Y1A	66	51	55
Y1	67	46	56
Y2	71	47	60
Y2A	72	55	62
Y3	75	48	63
Y3A	78	57	69
Y4	79	51	64
Y4F	80	57	66
Y5	82	52	68
Y5F	82	58	68
Y6	84	56	73
Y6A	84	63	78
Y7	86	54	69
Y7F	86	60	69
Y7A	86	69	73
Y8	88	58	75
Y8F	88	64	75
Y8A	90	72	83
Y9	92	60	72
Y9A	92	63	69
Y9F	92	68	78
A1	94	62	76
A2	94	70	84
A2A	96	66	75
A3	97	68	80
A4	97	76	88

Please quote the size and lordosis (0° or 15°) when ordering.

Boston Brace Vests

Standard Boston T

The Boston T is the perfect mate to wear under your Boston Brace. This white protective round neck body sock with single axilla flap is superior to a regular vest for cushioning. It stretches more than 150% to ensure a wrinkle-free fit under the Boston Brace. It is made from 95.6% CoolMax® and 4.4% Lycra®. CoolMax® includes an effective fibre-based moisture management system which moves perspiration away from the body and through the fabric where it evaporates quickly, allowing the wearer to feel cooler and more comfortable.



Item No.	Description	Specification	Size	Chest Circumference
1BP2BVSL	STANDARD BOSTON T	SINGLE AXILLA FLAP	SMALL	40-61cm
1BP2BVML	STANDARD BOSTON T	SINGLE AXILLA FLAP	MEDIUM	61-81cm
1BP2BVLL	STANDARD BOSTON T	SINGLE AXILLA FLAP	LARGE	81-101cm
1BP2BVXX	STANDARD BOSTON T	SINGLE AXILLA FLAP	X-LARGE	101-122cm

X-Static Boston T

The X-Static Boston T has the same benefits as the Standard T and is also available in double axilla flap. The material content in the single axilla flap comprises 49% polyester, 46.5% Nylon, 5% X-Static® and 2% Lycra®. X-Static® fibres help transport moisture away from the skin and prevent odour. It also has thermal and anti-static properties to keep you cool and comfortable. The double axilla flap comprises 95.6% Polyester/X-Static® blend and 4.4% Lycra®.

Item No.	Description	Specification	Size	Chest Circumference
1BX1BVSL	X-STATIC BOSTON T	SINGLE AXILLA FLAP	SMALL	40-61cm
1BX1BVML	X-STATIC BOSTON T	SINGLE AXILLA FLAP	MEDIUM	61-81cm
1BX1BVLL	X-STATIC BOSTON T	SINGLE AXILLA FLAP	LARGE	81-101cm
1BX1BVXX	X-STATIC BOSTON T	SINGLE AXILLA FLAP	X-LARGE	101-122cm
1BXBBDSL	X-STATIC BOSTON T	DOUBLE AXILLA FLAP	SMALL	40-61cm
1BXBBDML	X-STATIC BOSTON T	DOUBLE AXILLA FLAP	MEDIUM	61-81cm
1BXBBDLL	X-STATIC BOSTON T	DOUBLE AXILLA FLAP	LARGE	81-101cm
1BXBBDX	X-STATIC BOSTON T	DOUBLE AXILLA FLAP	X-LARGE	101-122cm

Strap Sets (3 straps/set)

Item No.	Description	Size
P190	BOSTON STRAP KIT	38 X 203 MM
P191	BOSTON STRAP KIT	38 X 254 MM
P192	BOSTON STRAP KIT	38 X 305 MM
P193	BOSTON STRAP KIT	38 X 356 MM
P194	BOSTON STRAP KIT	38 X 406 MM
P195	BOSTON STRAP KIT	38 X 457 MM
P196	BOSTON STRAP KIT	51 X 254 MM
P197	BOSTON STRAP KIT	51 X 305 MM
P198	BOSTON STRAP KIT	51 X 356 MM
P199	BOSTON STRAP KIT	51 X 406 MM
P200	BOSTON STRAP KIT	51 X 457 MM

Individual Straps

Item No.	Description	Size
S158	SINGLE STRAPS W/ LOOP & CHAFFE	38 X 203 MM
S1510	SINGLE STRAPS W/ LOOP & CHAFFE	38 X 254 MM
S1512	SINGLE STRAPS W/ LOOP & CHAFFE	38 X 305 MM
S1514	SINGLE STRAPS W/ LOOP & CHAFFE	38 X 356 MM
S1516	SINGLE STRAPS W/ LOOP & CHAFFE	38 X 406 MM
S1518	SINGLE STRAPS W/ LOOP & CHAFFE	38 X 457 MM
S210	SINGLE STRAPS W/ LOOP & CHAFFE	51 X 254 MM
S212	SINGLE STRAPS W/ LOOP & CHAFFE	51 X 305 MM
S214	SINGLE STRAPS W/ LOOP & CHAFFE	51 X 356 MM
S216	SINGLE STRAPS W/ LOOP & CHAFFE	51 X 406 MM
S218	SINGLE STRAPS W/ LOOP & CHAFFE	51 X 457 MM

Reinforcements (Boston Scoliosis Brace)

Item No.	Description	Size
R21P	POSTERIOR REINFORCEMENT	SMALL
R22P	POSTERIOR REINFORCEMENT	MEDIUM
R23P	POSTERIOR REINFORCEMENT	LARGE
R25A	ANTERIOR REINFORCEMENT	SMALL
R26A	ANTERIOR REINFORCEMENT	LARGE

Closure Fastenings (Boston Overlap Brace)

Item No.	Description	Size
CLOS-06	B.O.B FRONT CLOSURE	152 MM
CLOS-07	B.O.B FRONT CLOSURE	178 MM
CLOS-08	B.O.B FRONT CLOSURE	203 MM
CLOS-09	B.O.B FRONT CLOSURE	229 MM
CLOS-10	B.O.B FRONT CLOSURE	254 MM

Please quote item number when ordering

Boston LITE Accessories

Item No.	Description	Size
SBBL-L1	Boston LITE - Liner Only Size 1	To Fit Boston LITE Size 15J1-15J2
SBBL-L2	Boston LITE - Liner Only Size 2	To Fit Boston LITE Size 15J3-15J4
SBBL-L3	Boston LITE - Liner Only Size 3	To Fit Boston LITE Size 15Y1-15Y2
SBBL-L4	Boston LITE - Liner Only Size 4	To Fit Boston LITE Size 15Y1A-15Y2A
SBBL-L5	Boston LITE - Liner Only Size 5	To Fit Boston LITE Size 15Y3-15Y4
SBBL-L6	Boston LITE - Liner Only Size 6	To Fit Boston LITE Size 15Y3A-15Y4F
SBBL-S/SET	Boston LITE- Strap Set	Size of straps according to size of brace

Pads (Boston Scoliosis Brace)

Item No.	Description	Size
P101O	BOSTON BRACE PADS	TROCHANTER PAD SMALL
P102O	BOSTON BRACE PADS	TROCHANTER PAD LARGE
P104O	BOSTON BRACE PADS	ASIS PAD-SMALL LEFT
P105O	BOSTON BRACE PADS	ASIS PAD-SMALL RIGHT
P108O	BOSTON BRACE PADS	ASIS PAD-LARGE LEFT
P109O	BOSTON BRACE PADS	ASIS PAD-LARGE RIGHT
P110O	BOSTON BRACE PADS	LUMBAR PAD-SMALL LEFT
P111O	BOSTON BRACE PADS	LUMBAR PAD-SMALL RIGHT
P114O	BOSTON BRACE PADS	LUMBAR PAD-LARGE LEFT
P115O	BOSTON BRACE PADS	LUMBAR PAD-LARGE RIGHT
P116O	BOSTON BRACE PADS	THORACIC PAD-SMALL LEFT
P117O	BOSTON BRACE PADS	THORACIC PAD-SMALL RIGHT
P120O	BOSTON BRACE PADS	THORACIC PAD-LARGE LEFT
P121O	BOSTON BRACE PADS	THORACIC PAD-LARGE RIGHT
P122O	BOSTON BRACE PADS	LUMBAR LEFT-ANTI ROTATION
P124O	BOSTON BRACE PADS	LUMBAR RIGHT-ANTIROTATION

Posterior Reinforcements (Boston Overlap Brace)

Item No.	Description	Size
PARA-08	B.O.B.POSTERIOR REINFORCE STAY, STEEL SPRING	203 MM
PARA-09	B.O.B.POSTERIOR REINFORCE STAY, STEEL SPRING	229 MM
PARA-10	B.O.B.POSTERIOR REINFORCE STAY, STEEL SPRING	254 MM
PARA-11	B.O.B.POSTERIOR REINFORCE STAY, STEEL SPRING	279 MM
PARA-12	B.O.B.POSTERIOR REINFORCE STAY, STEEL SPRING	305 MM
PARA-13	B.O.B.POSTERIOR REINFORCE STAY, STEEL SPRING	330 MM
PARA-14	B.O.B.POSTERIOR REINFORCE STAY, STEEL SPRING	356 MM

Please quote item number when ordering

Colour Transfers

All over pattern transfers - Suitable for rigid braces only

Item No.	Description	Size
TP5	BLUE	All Over
TP21	BUTTERFLY II	All Over
TP11	CARBON BRAID	All Over
TP32	CARRIBEAN	All Over
TP4	DARK SKY	All Over
TP18	FOOTBALL BLUE	All Over
TP35	FOOTBALL GREEN	All Over
TP24	ICE AGE	All Over
TP13	JEANS / DENIM	All Over
TP19	LAVA	All Over
TP31	LEOPARD	All Over
TP29	LIGHT BEIGE	All Over
TP12	LIGHT PINK	All Over
TP14	MILITARY CAMOUFLAGE	All Over
TP6	OCEAN	All Over
TP27	STARLIGHT	All Over
TP25	TATTOO	All Over
TP3	TORNADO	All Over
TP30	ZEBRA	All Over

Single placement transfers - Suitable for rigid braces only

Item No.	Description	Size mm
PTWB2-SOLO	BATMAN	90 x 110
PTBGS-SOLO	BUGS BUNNY	90 x 140
PTPENELOPE-SOLO	PENELOPE	95 x 130
PTSM-SOLO	SPIDERMAN	80 x 150
PTSUM-SOLO	SUPERMAN	75 x 150
PTTW-SOLO	TWEETY BIRD	90 x 140

Colours Foam - Suitable for Soft Braces only

Item No.	Colour
BSBJ/COL	BLUE
BSBJ/COL	ORANGE
BSBJ/COL	PINK
BSBJ/COL	PURPLE

*** Please note that colours and patterns may vary and can be discontinued from time to time ***

Please quote item number when ordering

Boston Brace Transfer - All Over Pattern

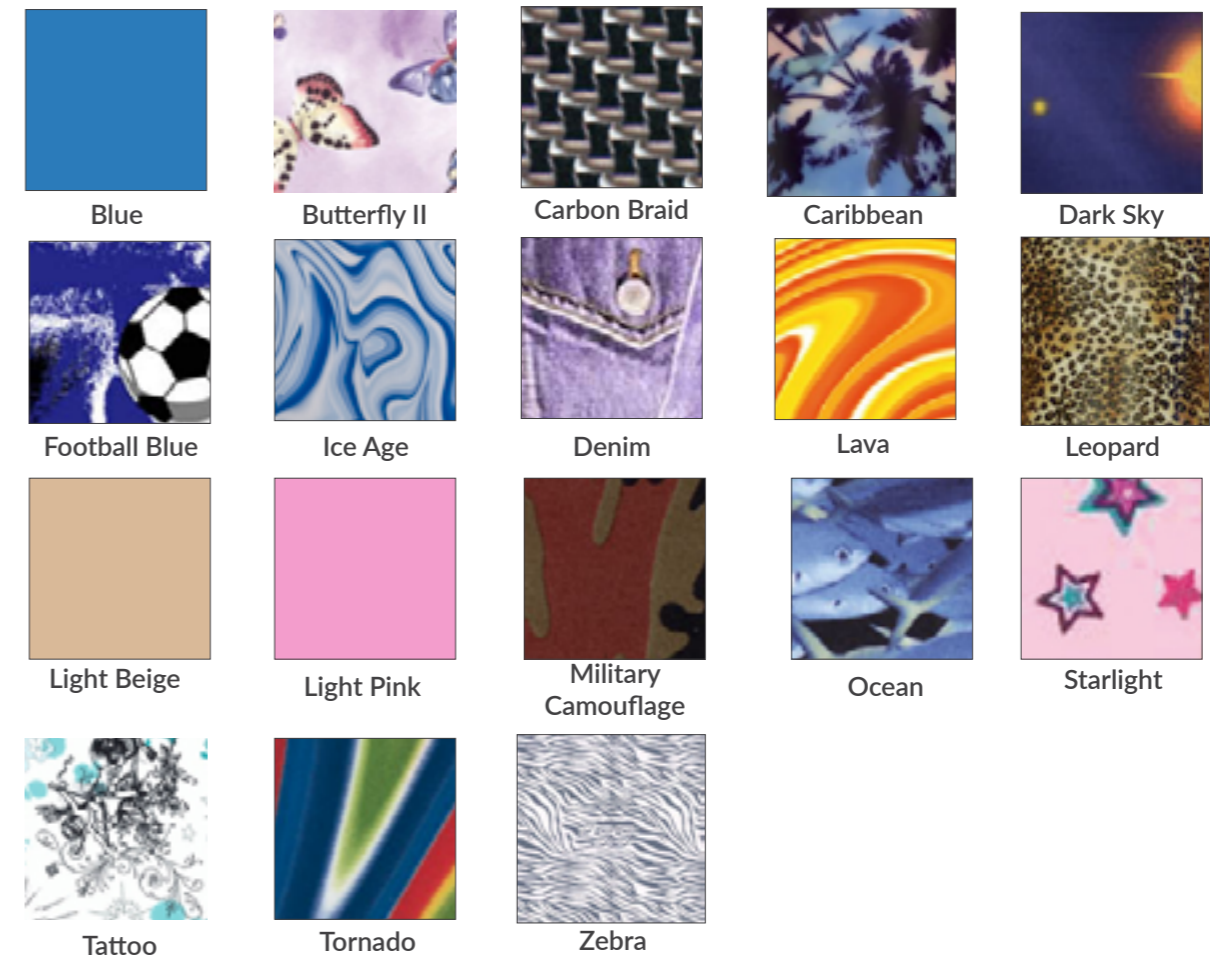

Boston Brace Transfer Single

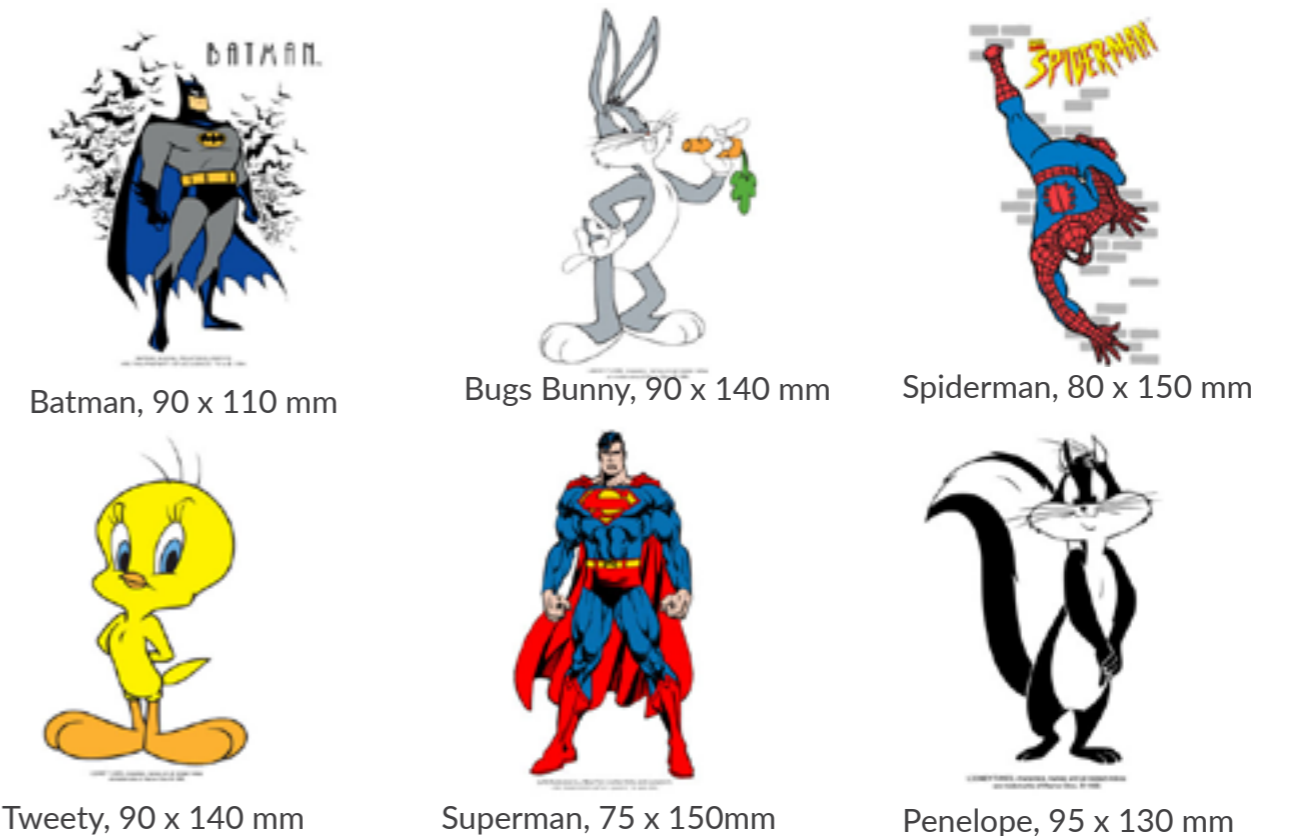

Allard Support UK Ltd - General Terms and Conditions of Sale

Prices

Prices are effective from 1 January 2025. All Prices exclude VAT and delivery charges.

Payment Terms

Standard terms are net 30 days from Invoice date.

Overdue accounts are subject to a charge of 1.5% interest on the unpaid balance.

Delivery

It is our aim to despatch all stock size orders received by 2pm on the same day. If for any reason we are unable to meet that aim, you will be contacted. Customised orders will be despatched in accordance with the manufacturing lead time of the product. This will be communicated to you on receipt of the order.

Returns

- Customised items are not returnable for exchange or credit.
- Not-for-Resale items are not returnable for exchange or credit.
- Stock items more than 2 months old are not returnable.
- Items may not be returned without a Return Authorisation Number. Please call us in order to receive a Return Authorisation Number prior to shipping the product.
- Stock items returned for credit (cost of goods only) will be charged a 5% re-stocking fee. Any such returned goods must be unmarked and undamaged in any way.
- Incorrectly supplied items will be credited in full (cost of goods, plus initial delivery charges to customer, plus return charges to Allard UK Ltd – subject to verification of such return charges).
- Defective goods will be credited in full (cost of goods, plus initial delivery charges to customer, plus return charges to Allard UK Ltd – subject to verification of such charges) OR replaced (and credit for cost of return charges to Allard UK Ltd – subject to verification of such return charges). Allard UK will examine all returned “defective” items to ascertain the validity of such claims. The customer will be notified of outcome of such examination and the applicable credit or replacement within a reasonable period of time.

ALLARD AFO Warranty

Allard UK return’s policy for Allard AFO products assumes that fitting has been done correctly, adjustments have been carried out according to Professional Instructions supplied and the Patient Instruction has been reviewed with the patient. The Patient Instructions should be given to the patient or the caregiver to take home. Our return policy is that we grant warranty for defects in material and workmanship as indicated by specific products listed below:

All ALLARD AFOs (except Custom)

Allard UK will provide at no charge to the provider, a replacement product of equal value for any Allard AFO.

- Choice of specific product, and product size is at the discretion of the provider.
- Replacement is limited to two orthoses for the same patient that is returned within one year from date of the initial fitting of the Allard AFO.

All Allard Custom AFO

Allard UK grants warranty for defects in material and workmanship and will provide at no charge to the provider a replacement Allard AFO Custom of equal value, provided the replacement does not require change in position of the strut or change in heel height (unless the change is required due to a fabrication error). There will be an additional charge if the replacement requires a change in properties not specified in the original order, for example changes in A-P and/or M-L stiffness. Replacement is limited to one orthosis for the same wearer that is returned within one year from date of initial fitting. The product should be inspected on receipt and if the AFO does not meet order requirements the provider should contact Allard UK immediately.

KiddieFLOW™, KiddieGAIT®, KiddeROCKER®

Allard UK will provide at no charge to the provider, a replacement product of equal value for either Allard AFO listed above.

- Choice of specific product, as listed above is at the discretion of the provider.
- Replacement is limited to one orthosis for the same patient that is returned within six months from date of the initial fitting of the Allard AFO.

IMPORTANT

- To get a replacement you need to contact Allard UK Customer Support and provide us with the Serial Number of the product. The product must be sent back to Allard UK together with our Return form.
- This warranty does not cover change in function or damage done by tools, application of heat, or excessive bending/flexing back and forth of the wings.
- Replacement does not include fitting, modification or other provider costs.

Support for Better Life

Everyone should be able to live their life to the fullest, regardless of their mobility challenges. With innovative solutions developed in close collaboration with healthcare professionals and patients, we strive to provide Support for Better Life.

allard

Allard Support UK Ltd.

Coes Road, Dundalk, Co. Louth, A91 E868 | +353 42 932 8177 | info@allarduk.co.uk | allarduk.co.uk